

Enphase Envoy-S



Contact Information

Enphase Energy Inc.
1420 N. McDowell Blvd.
Petaluma, CA 94954

enphase.com

enphase.com/en-us/support/contact

FCC Compliance

This equipment has been tested and found to comply with the limits for a Class B digital device, pursuant to part 15 of the FCC Rules. These limits are designed to provide reasonable protection against harmful interference in a residential installation. This equipment generates, uses and can radiate radio frequency energy and, if not installed and used in accordance with the instructions, may cause harmful interference to radio communications. However, there is no guarantee that interference will not occur in a particular installation. If this equipment does cause harmful interference to radio or television reception, which can be determined by turning the equipment off and on, you are encouraged to try to correct the interference by one or more of the following measures:

- Reorient or relocate the receiving antenna.
- Increase the separation between the equipment and the receiver.
- Connect the equipment into an outlet on a circuit different from that to which the receiver is connected.
- Consult the dealer or an experienced radio/TV technician for help.

Changes or modifications not expressly approved by the party responsible for compliance may void the user's authority to operate the equipment.

Other Information

This Class B digital apparatus complies with Industry Canada ICES-003.

For third-party license information, refer to enphase.com/licenses.

For Enphase patent information, refer to enphase.com/company/patents/.

Product information is subject to change without notice. All trademarks are recognized as the property of their respective owners.

For warranty text, refer to enphase.com/warranty.

User documentation is updated frequently; Check the Enphase website (enphase.com/support) for the latest information.

Copyright © 2017 Enphase Energy Inc. All rights reserved.

Audience

This manual is intended for use by professional installation and maintenance personnel.

Table of Contents

SAFETY	5
Read this First	5
Safety Instructions	5
The Enphase Envoy-S	6
How the Enphase Microinverter System Works	6
Installation Planning and Preparation	7
Pre-installation Checks	8
Select the Envoy-S Type to Install	8
Plan the Power Connection	8
Plan the Internet Connection	8
Download the Installer Toolkit App	8
Metering Considerations	9
Box Contents	9
Required Items	9
Optional Items	9
System Metering Options	10
Create the Map and Install the PV Modules and Microinverters	10
Installation Sequence	11
Installing the Envoy-S	12
1. Choose a Location for the Envoy-S	13
2. Provide a Power Connection	13
Provide Power for the Envoy-S Standard (ENV-S-AB-120-A)	13
Provide Power for the Envoy-S Metered (ENV-S-AM1-120)	15
3. Install CTs for Metering (Model ENV-S-AM1-120 only)	16
Install the CT for Production Metering	17
Install CTs for Consumption Metering (Optional)	17
Extend Consumption CT Leads, If Needed	18
4. Energize the Envoy-S	18
5. Detect the Microinverters	19
Method A: Provision Microinverters with Installer Toolkit	19
Method B: Discover Microinverters with Installer Toolkit	19
Method C: Discover Microinverters with the Envoy-S	20
With All Methods	20
6. Verify System Configuration	20
7. Connect to Enlighten	21
Method A: Integrated Wi-Fi	21
Method B: Enphase Mobile Connect Modem	22
Method C: Ethernet Cable	22
Method D: Power Line Communication Bridges	23
If the Internet Connection Fails	23
8. Send System Summary Report	23
Activate Monitoring	24
Method A: If the Envoy-S is Associated with a System in Installer Toolkit	24
Method B: If the Envoy-S is NOT associated with a System in Installer Toolkit	24
View System Performance in Enlighten	24
Envoy-S Operation	25
Envoy-S Displays and Controls	25
Envoy-S LED States	25
LED Behavior at Initial Start Up	26
Initial Communications Check	26
More about Device Communications States	26
Initiate a New Scan for Microinverters	26



Connecting to Envoy-S	27
Connect Using the Installer Toolkit App	27
Method A: Use the Site's Wireless Router to Connect to the Envoy-S.....	27
Method B: Create a Wireless Access Point	27
Complete the Connection to Envoy-S with Installer Toolkit	28
Connect Remotely Using Enlighten.....	30
Connect Using the Envoy-S Local Interface	31
View Production Readings.....	31
View or Change Monitoring Settings.....	32
View Microinverter Information	35
View Envoy Information	35
Open a Connection for Enphase Troubleshooting.....	35
Troubleshooting.....	36
Microinverter Detection Issues	36
Issue: Installer Toolkit Shows "Cross Domain Traffic Reported"	36
Issue: Device Communications LED is Solid Amber	36
Issue: Installer Toolkit Detects Fewer Microinverters than Expected	36
Issue: No Microinverters are Reporting	37
Issue: Installer Toolkit Indicates that Scanning is Inhibited	37
Power Production Issues.....	37
Issue: Power Production LED is solid amber.....	37
Internet Connection Issues.....	38
Issue: Network Communications LED is Amber or Off	38
Issue: Wi-Fi Problems.....	39
Issue: Cellular Modem Connection Status "Not Connected"	39
Issue: Envoy-S is not Connecting with a New Router.....	39
Local Networking Considerations.....	39
DHCP versus Static IP Addressing.....	39
MAC Filtering	40
Firewall Settings.....	40
Microinverter Issues	40
Clear "DC Resistance Low - Power Off" Condition.....	40
Clear "GFI Tripped" Condition.....	42
Replacing an Envoy-S	44
Replacing an Envoy-S Standard (non-hardwired)	44
Replacing a Hardwired Envoy-S.....	45
Technical Data.....	47

SAFETY





Read this First

Follow the instructions in this manual. These instructions are key to the installation and maintenance of the Enphase Envoy-S Standard™ and the Enphase Envoy-S Metered™.

To ensure the safe installation and operation of the Envoy-S, note the following safety symbols that appear throughout this document to indicate dangerous conditions and important safety instructions.

	DANGER:	This indicates a hazardous situation, which if not avoided, will result in death or serious injury.
	WARNING:	This indicates a situation where failure to follow instructions may be a safety hazard or cause equipment malfunction. Use extreme caution and follow instructions carefully.
	NOTE:	This indicates information that is very important for optimal system operation. Follow instructions closely.

Safety Instructions

	DANGER:	Do not install current transformers (CTs) when current is flowing in the sensed circuit. Always install CT wires in the terminal blocks before energizing the sensed circuit. Risk of electrocution!
	DANGER:	Do not attempt to repair the Envoy-S; it contains no user-serviceable parts. Tampering with or opening the Envoy-S will void the warranty. If the Envoy-S fails, contact Enphase Customer Support for assistance at enphase.com/en-us/support/contact . Refer servicing to qualified personnel. Risk of electric shock. Risk of fire. Only qualified personnel should troubleshoot, install, or replace the Envoy-S. Do not wire unused terminals or terminal blocks on the Envoy-S.
	DANGER:	Do not use Enphase equipment in a manner not specified by the manufacturer. Doing so may cause death or injury to persons, or damage to equipment. Risk of electric shock. If you wire the Envoy-S at the subpanel, always de-energize the subpanel before beginning wiring.
	WARNINGS:	Before installing or using the Envoy-S, read all instructions and cautionary markings in the technical description and on the Envoy-S. Risk of equipment damage. When installing the Envoy-S in an enclosure, choose area for installation where ambient temperature does not exceed 46° C (115° F).
	NOTES:	Perform all wiring in accordance with all applicable local electrical codes, with the Canadian Electrical Code, Part I, and with the National Electrical Code (NEC), ANSI/NFPA 70. To ensure optimal reliability and to meet warranty requirements, the Enphase Envoy-S must be installed according to the instructions in this manual.

The Enphase Envoy-S

The Enphase Envoy-S is an integral component of the Enphase Home Energy Solution. It operates between the Enphase devices, or other PV system, and the Enphase Enlighten™ web-based monitoring and analysis software. When used with Enphase devices, the Envoy-S can control grid management functions and monitor PV production and site consumption. When used with non-Enphase PV systems, it can collect production and consumption data, but does not control grid management functions.

How the Enphase Microinverter System Works

The Enphase Microinverter converts the DC output of the PV module into grid-compliant AC power. In addition to performing the DC to AC conversion, it maximizes energy production by using a sophisticated Maximum Power Point Tracking (MPPT) algorithm. This integrated system maximizes energy harvest, increases system reliability, and simplifies design, installation and management.

The Envoy-S operates as a gateway between the Enphase devices and Enlighten. It collects energy and performance data from the PV system over on-site AC power lines, and it forwards that data to Enlighten, via the Internet, for statistical reporting. Enlighten analyzes the data collected by each Enphase device connected to the Envoy-S. Essential for system monitoring and troubleshooting, Enlighten automatically detects any shortfall in energy production, identifies possible causes, and suggests solutions.

Enlighten provides a wide range of information on system performance. You can access Enlighten on your computer or mobile device and view current performance information at any time.

- The **Envoy-S Metered** uses precision Current Transformers (CTs) to measure PV production and home energy consumption.
- The **Envoy-S Standard** offers microinverter PV production monitoring.



Installation Planning and Preparation

Installation and operation of the Envoy-S requires no specialized equipment or unique computer or networking expertise. To the Local Area Network (LAN), the Envoy-S is just another host on the network, much like a personal computer. The Envoy-S simply connects to the on-site router or Enphase Mobile Connect™ (cellular modem) for communications with the Enphase Enlighten monitoring and analysis website. The Envoy-S communicates with the microinverters using the site's power lines.

After the Envoy-S is installed and the microinverters are scanned or provisioned, it maintains an internal database of all known Enphase Microinverters at the site it manages. At regular intervals, the Envoy-S polls each microinverter for its energy data. Using its Internet connection, the Envoy-S then forwards that information to Enlighten. The Envoy-S also reports any error conditions that affect it or the microinverters. You can view both energy data and error conditions in Enlighten.

The Envoy-S incorporates power line and Internet communications functions. One "side" of the Envoy-S communicates with the microinverters through power lines at the site. The other "side" of the Envoy-S communicates with Enlighten over the Internet.

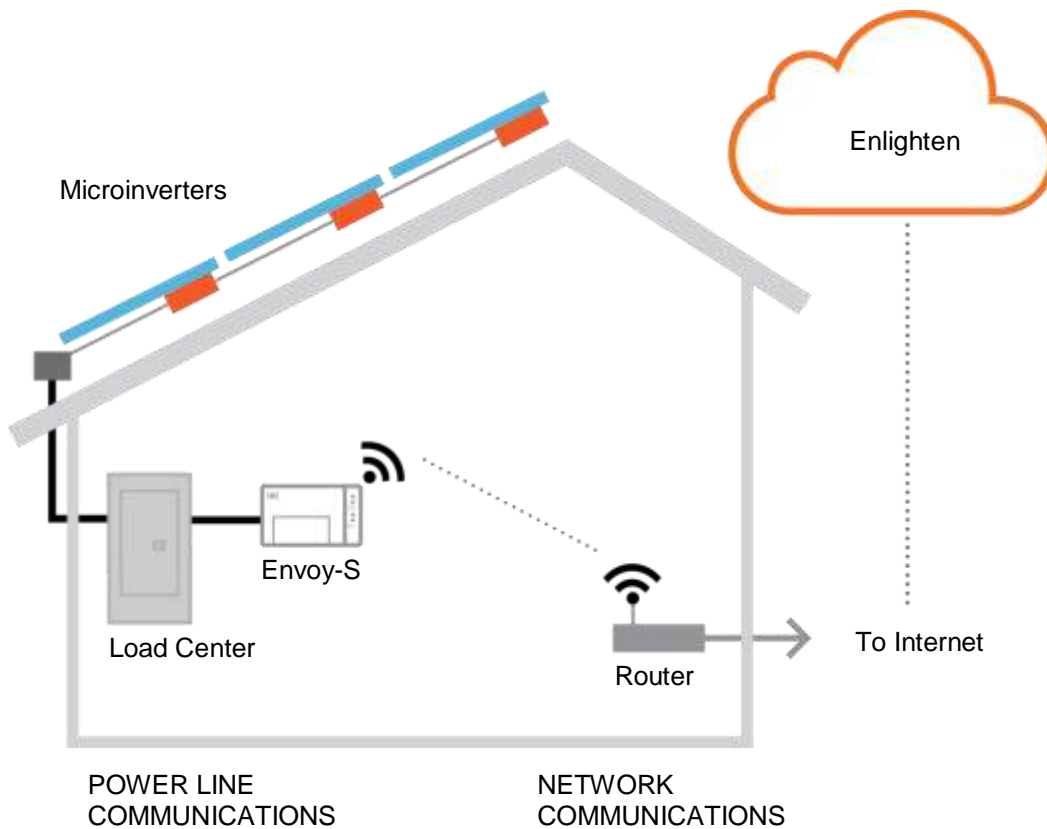

Pre-installation Checks

Review the following pre-installation checks before you install the Envoy-S.

Select the Envoy-S Type to Install

- The **Envoy-S Metered** uses precision Current Transformers (CTs) to measure PV production (accuracy 2.5%) from the solar main supply switch and home energy consumption from the AC mains.
- The **Envoy-S Standard** offers microinverter PV production monitoring (accuracy +/- 5%).

Plan the Power Connection

If installing the Envoy-S Standard, decide whether to power the Envoy-S using the included AC power cord or by hardwiring the Envoy-S in a NRTL certified, NEMA type 3R (or better) enclosure. Use an appropriately rated enclosure if hard-wiring indoors. Make sure that the site has either a standard AC outlet available near the AC load center in which the Envoy-S can be hardwired. Do not use a power strip. If you use the power cord in an enclosure, the socket must be appropriately rated.

Plan the Internet Connection

Additional requirements to use the **Enlighten** web-based monitoring and analysis software are:

- Internet connection for the Envoy-S through a traditional router or modem or Enphase Mobile Connect (Enphase model CELLMODEM-01). Decide whether to connect the Envoy-S to the Internet using integrated Wi-Fi, an Enphase Mobile Connect modem, or using a PLC bridge with Ethernet cables.
- One of the following Web browsers with cookies enabled: Chrome 44 or higher, Firefox 41 or higher, Internet Explorer 11, Microsoft Edge for Windows, Safari 8 or higher.

Download the Installer Toolkit App

The Enphase Installer Toolkit is a mobile app for iOS and Android devices that allows installers to configure the system while onsite, eliminating the need for a laptop and improving installation efficiency.

- Download the Enphase Installer Toolkit mobile app and open it to log in to your Enlighten account. With this app, you can connect to the Envoy to track system installation progress. To download, go to enphase.com/installer-toolkit or scan the QR code:
- To run the Installer Toolkit app, you need either of the following mobile devices:
 - An Android mobile device running Android version 5 (Lollipop) or later, or
 - An iOS device running iOS 8 or later.



Enphase Installer Toolkit mobile app

Metering Considerations

The Envoy-S Metered includes a production CT and you may order two consumption CTs for consumption monitoring. When installing CTs:

- Do not install the CTs in a panel where they exceed 75% of the wiring space of any cross-sectional area within the panel, or refer to local standards for guidance.

To install the **production CT**

- Ensure there is sufficient room to install the production CT around line 1 of the solar PV disconnect.

To install **consumption CTs** (order CT-200-SPLIT separately)

- For net consumption metering, ensure there is sufficient room to install both CTs around lines 1 and 2 from the main feeds.
- For total consumption metering, ensure there is sufficient room to install the CTs around the lines that feed the consumption circuit.

Box Contents

Check the shipping box for the following items:

- Enphase Envoy-S
- AC power cord (included with ENV-S-AB-120-A)
- Production metering CT (included with ENV-S-AM1-120)
- Length of DIN rail for mounting
- Ferrite bead to attach to your Ethernet Cable, if used
- *Enphase Envoy-S Quick Install Guide*

Required Items

If you hard-wire the Envoy-S, you must install it in a **NRTL certified NEMA type 3R (or better) enclosure with conduit attachment**. Note that Metallic enclosures may impair Wi-Fi signal strength. Do not drill holes for conduit at the top of the enclosure or anywhere that allows moisture ingress.

Optional Items

Make sure you have the following optional items, if needed:

- Two consumption metering split-core CTs (order two CTs: Enphase CT-200-SPLIT)
- Enphase Mobile Connect modem (order Enphase CELLMODEM-01)
- Ethernet over power line communication (PLC) bridge with Ethernet cables (order Enphase EPLC-01)
- Ethernet cable (use only 802.3, unshielded Cat5E or CAT 6). Do not use shielded twisted pair (STP) cable.

System Metering Options

The Envoy-S monitors up to 600 Enphase Microinverters and up to 39 Enphase AC Batteries. The Envoy-S is available with standard or revenue-grade metering options. Check that the model number is correct for your installation.

Envoy-S name and model number (SKU)	Metering / reporting	Includes AC power cord or CT
Envoy-S Standard ENV-S-AB-120-A (white case)	Standard PV production monitoring (+/- 5%).	AC power cord
Envoy-S Metered ENV-S-AM1-120 (black case)	Integrated revenue grade PV production metering (ANSI C12.20 +/- 0.5%) and optional consumption monitoring (+/- 2.5%). <ul style="list-style-type: none"> • Revenue-grade production metering • Optional consumption metering (requires additional CTs, order CT-200-SPLIT) 	Production CT



NOTE: To install **multiple** Envoys at a single site, see our technical brief on commercial design at enphase.com/support.

Create the Map and Install the PV Modules and Microinverters

Create the map and install the PV modules and microinverters. You will scan this map later using Installer Toolkit and your mobile device. (See “Method A: Provision Microinverters with Installer Toolkit” on page 19.



NOTE: If needed, you can find an installation map at the back of any Enphase Microinverter manual.

- Create a paper installation map to record microinverter serial numbers and positions in the array. Peel the removable serial number label from each microinverter and affix it to the respective location on the installation map.
- Peel the removable label from the bottom of the Envoy-S and affix it to the installation map.
- Always keep a copy of the installation map for your records.

Installation Sequence

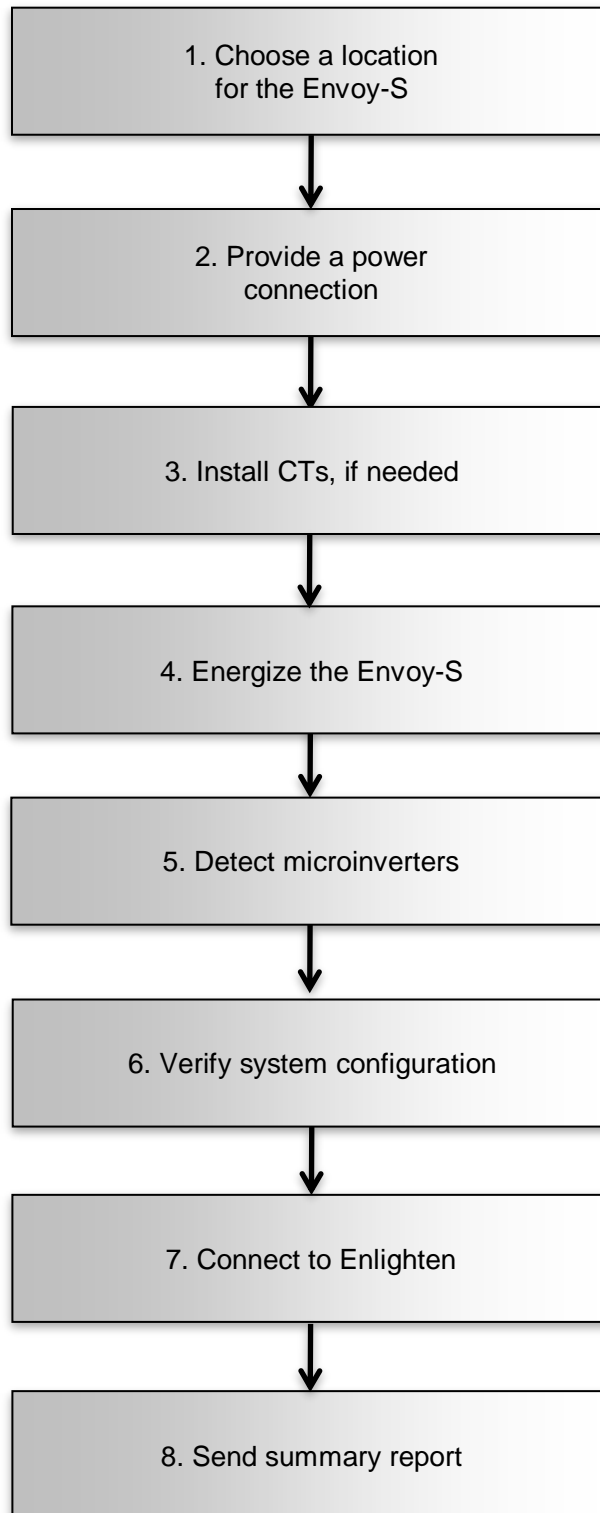

Installing the Envoy-S

To install the Envoy-S, perform the following steps and refer to these diagrams:

Envoy-S Standard (model number ENV-S-AB-120-A)

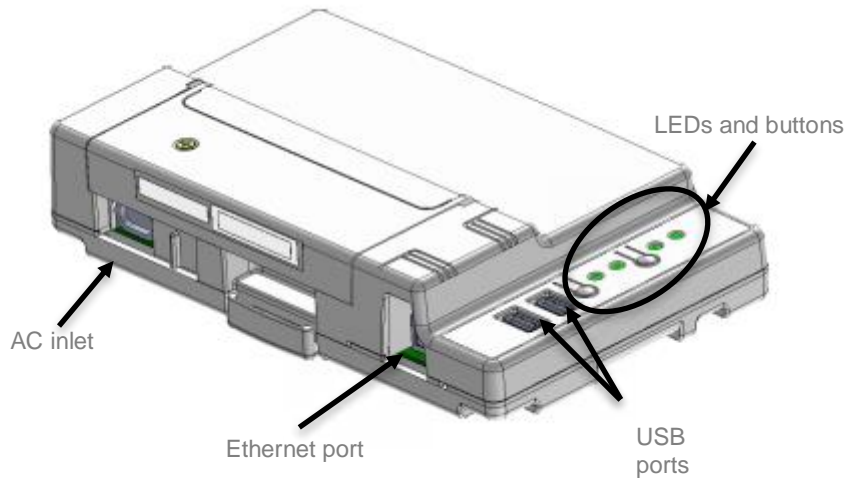

Envoy-S Metered (model number ENV-S-AM1-120)

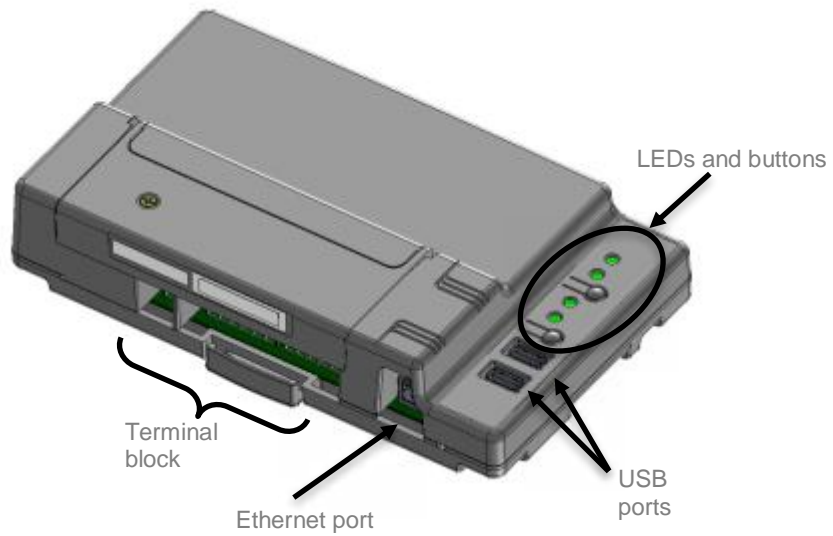

1. Choose a Location for the Envoy-S

- a. Install the Envoy-S at the subpanel or as close to the load center or Point of Common Coupling (PCC) as possible. This ensures that the Envoy-S receives the strongest possible communications signal from each microinverter.
- b. Install the Envoy-S in a protected dry space (such as a garage, attic, basement, or other cool, dry location). If the Envoy-S is hard-wired, you must also install it inside a NRTL certified NEMA type 3R (or better) enclosure with conduit attachment. Use an appropriately rated enclosure if hard-wiring indoors.



NOTE: Metallic enclosures may impair Wi-Fi signal strength.

- c. Mount the Envoy horizontally using the included DIN rail.



WARNING: Risk of equipment damage. When installing the Envoy-S in an enclosure, choose area for installation where ambient temperature does not exceed 46° C (115° F).

- d. To **wall-mount**, use two #8 screws and a screwdriver. Mount the DIN rail first, then clip the Envoy-S to the DIN rail.

2. Provide a Power Connection

The Envoy-S is available in two configurations.

- The **Envoy-S Standard (ENV-S-AB-120-A)** includes an AC power cord.
- The **Envoy-S Metered (ENV-S-AM1-120)** must be hard-wired (does not include an AC power cord)

The following sections provide separate instructions for the two configurations.

Provide Power for the Envoy-S Standard (ENV-S-AB-120-A)

Use one of the following methods to provide power to the Envoy-S Standard (ENV-S-AB-120-A).

Method A: Plug the Envoy into a 120 VAC Outlet

The Envoy-S Standard (ENV-S-AB-120-A) includes an AC power cord.



WARNING: If the included power cord is missing or lost, you must use a UL listed junior hard service max three-foot cord with a NEMA configuration 1-15P plug, rated for a minimum of 125 VAC with a type IEC 60320-C7 connector.

- a. Locate an AC outlet that is near the load center or PCC. If located outdoors, the outlet must be appropriately rated.
- b. Plug the AC power cord into the AC inlet on the Envoy-S.
- c. Plug the other end of the power cord into a dedicated 120 VAC outlet (not a power strip).



WARNING! Do **not** plug the Envoy-S into a power strip, surge protector, or uninterruptible power supply (UPS). The surge suppression or filtering in these devices impedes power line communication performance. Also, if possible, do not plug a power strip into the same outlet that the Envoy-S is using. The surge suppression or filtering components of a power strip may still interfere with communications if they are near the Envoy-S.

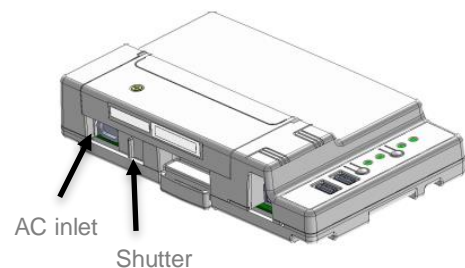

Method B: Wire in an Enclosure

Though the Envoy-S Standard (ENV-S-AB-120-A) includes an AC power cord, you may hard-wire it instead. When you hard-wire the Envoy-S, you must install it in a NRTL certified NEMA type 3R-rated (or better) enclosure with conduit attachment.



DANGER! Risk of electric shock. Be aware that installation of this equipment includes risk of electric shock. If you wire the Envoy-S at the subpanel, always de-energize the subpanel before beginning wiring.

- a. Use a 15 A maximum circuit breaker for the supply wiring.
- b. Make sure supply wiring is 14 AWG copper rated at 75° C.
- c. Locate the screw on the left side of the terminal block door, and loosen it with a screwdriver to unlock the door.
- d. Open the terminal block door and move the shutter to the left. Wire the line and neutral conductors as shown in the diagram. Tighten terminal block screws to 5 in-lbs (0.56 Nm).
 - Connect Line 1 to A
 - Connect Neutral to N

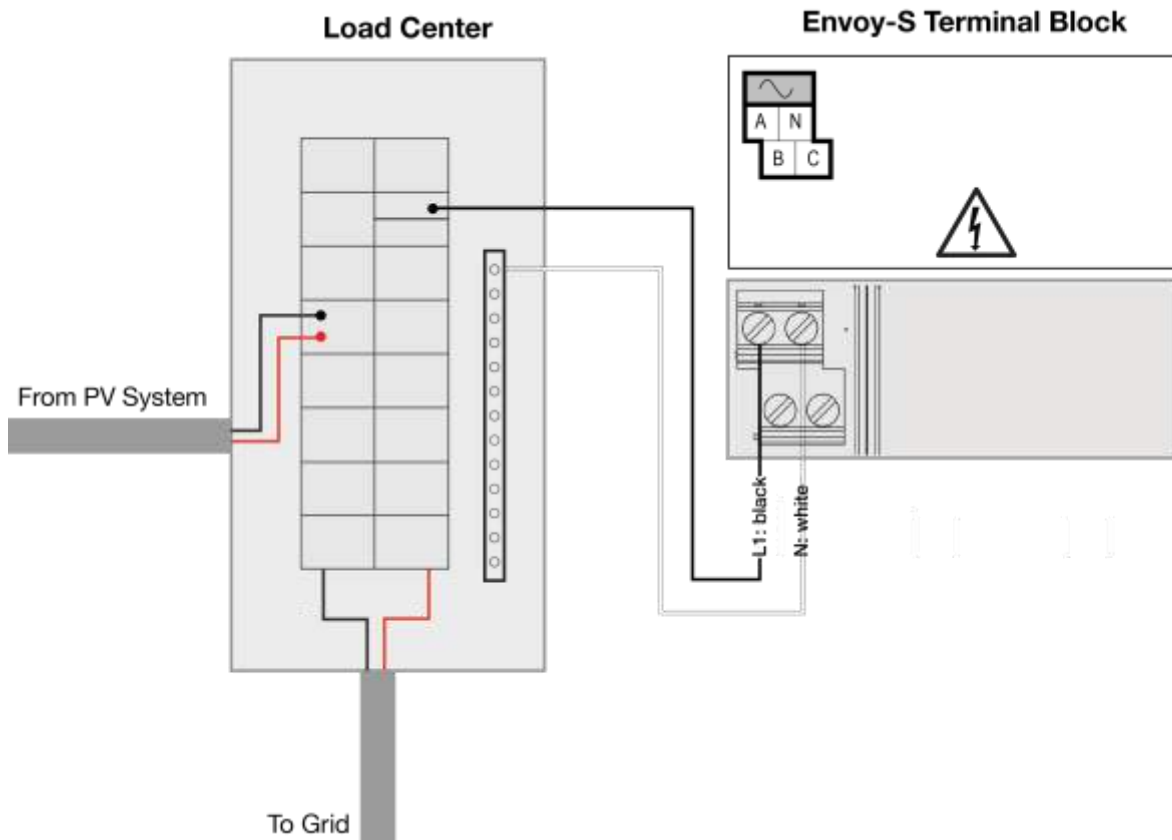

Provide Power for the Envoy-S Metered (ENV-S-AM1-120)

The Envoy-S Metered (ENV-S-AM1-120) uses terminal blocks for power connections. It does not include an AC power cord, and you **must** hard-wire it. When you hard-wire the Envoy-S, you must install it in a ventilated, NRTL certified NEMA type 3R-rated (or better) enclosure with conduit attachment.



DANGER! Risk of electric shock. Be aware that installation of this equipment includes risk of electric shock. If you wire the Envoy-S at the subpanel, always de-energize the subpanel before beginning wiring.

- a. Use a 15 A maximum circuit breaker for the supply wiring.
- b. Make sure supply wiring is 14 AWG copper rated at 75° C or better.
- c. Locate the screw on the left side of the terminal block door, and loosen it with a screwdriver to unlock the door.
- d. Flip open the terminal block door and wire the line and neutral conductors as shown in the diagram.
 - Connect Line 1 to A
 - Connect Line 2 to B
 - Connect Neutral to N
- e. Tighten all connections to 5 in-lbs (0.56 Nm).

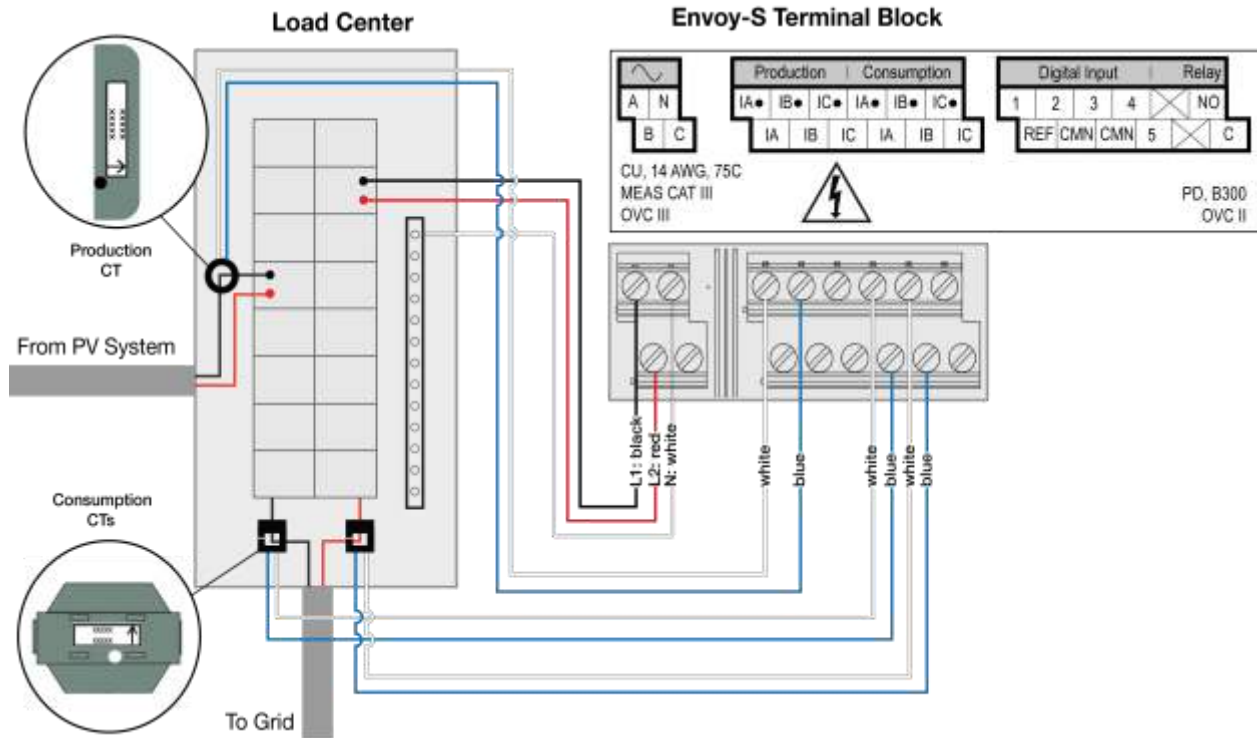

3. Install CTs for Metering (Model ENV-S-AM1-120 only)

The Envoy-S Metered (ENV-S-AM1-120) uses terminal blocks for metering connections. It includes UL listed energy-monitoring CTs to provide revenue grade production metering and to provide (optional) consumption metering. When wiring the Envoy-S for production and consumption metering, be sure to install the current transformers (CTs) exactly as described for your application. You must use a protected route in conduit for the CT wires from the AC mains to the Envoy-S. If you need to extend the leads, see “Extend Consumption CT Leads, If Needed” on page 18.



DANGER! Risk of electrocution! CTs must be installed with no current flowing in the sensed circuit. Always install CT wires in the terminal blocks before energizing the sensed circuit.



DANGER! Risk of electric shock. Be aware that installation of this equipment includes risk of electric shock. If you wire the Envoy-S at the subpanel, always de-energize the main load center before beginning wiring. If the subpanel cannot be de-energized, a qualified electrician may safely install the CTs as directed, making sure to connect the leads and then place the CTs around each wire and latch.



WARNING! Do not install the CTs in a panel where they exceed 75% of the wiring space of any cross-sectional area within the panel.



NOTES:

When wiring the Envoy-S for production and consumption metering, be sure to install the current transformers (CTs) exactly as described for your application.

When using CTs, do not energize the Envoy-S or the microinverters before the CT installation is complete.

Do not install the CTs in a panel where they exceed 75% of the wiring space of any cross-sectional area within the panel, or refer to local standards for guidance.

Only run active conductors through the CT. The CT can monitor multiple active conductors. You may run more than one wire through the CT if all wires are on the same phase and they fit the opening in the CT.

Use the following diagram as a reference while installing the CTs:

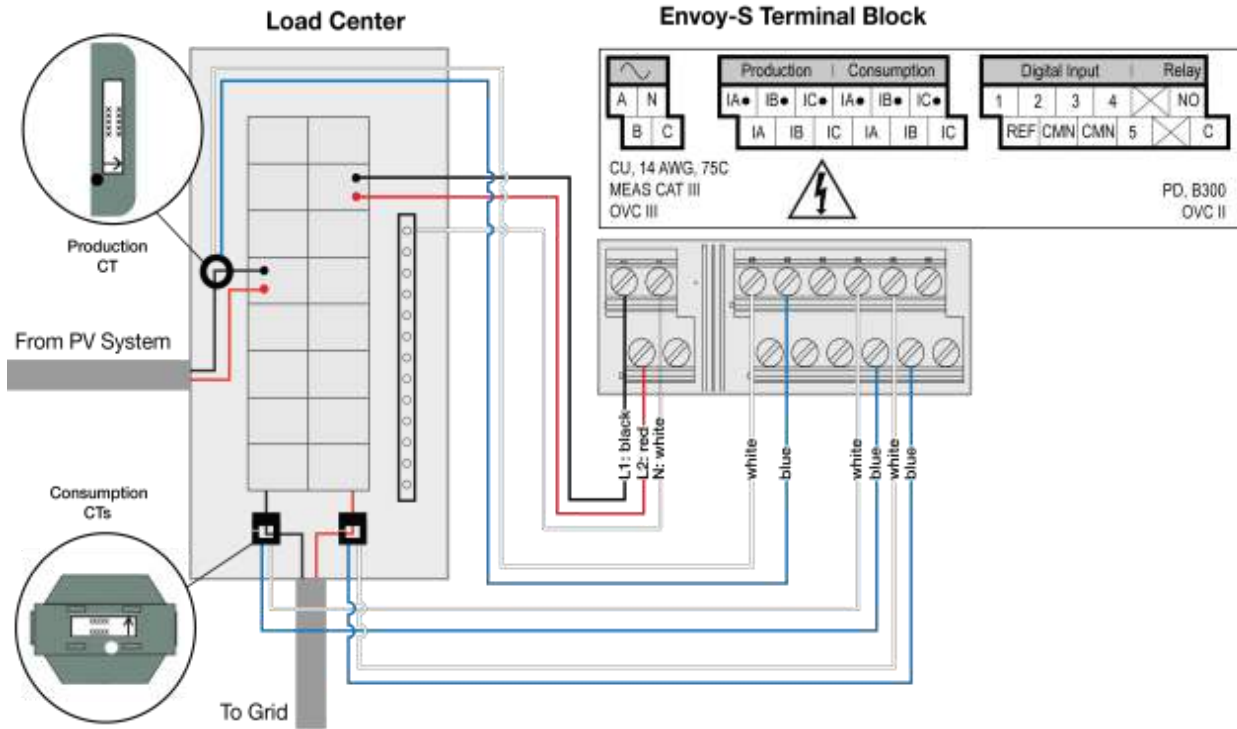

Install the CT for Production Metering

Use only the CT that came with the Envoy-S. It has the same serial number as the Envoy-S.

- a. Locate the arrow on the CT label.
- b. Connect the white wire to the “IA•” terminal.
- c. Connect the blue wire to the “IB•” terminal.
- d. Tighten the terminal block screws to 5 in-lbs (0.56 Nm).
- e. Clamp the CT on Line 1 (matching Envoy’s “A” voltage terminal) of the solar production circuit with the arrow pointing toward the load (away from the solar array).

Install CTs for Consumption Metering (Optional)

Install two split-core CTs (order two CT-200-SPLIT) to provide consumption metering. Create a protected route with conduit for the CT wires to the Envoy-S.

- a. Make sure that the main load center wires are de-energized until you have secured the CT wires in the terminal blocks. Before running the CT wires through the conduit, use colored tape to mark one of the CTs and the free end of its wires.
- b. For the marked CT wires, connect the white wire to “IA•” and the blue wire to “IA”.
- c. For the unmarked CT wires, connect the white wire to “IB•” and the blue wire to “IB”.
- d. Tighten the terminal block screws to 5 in-lbs (0.56 Nm).
- e. Clamp the marked CT on the load center feed wire Line 1 (matching the Envoy’s “A” voltage terminal) with the CT arrow pointing toward the load (away from the grid). Unlatch the CT and place Line 1 in through the opening. Latch the CT and listen for the click as it closes.
- f. Clamp the unmarked CT on the load center feed wire Line 2 (matching the Envoy’s “B” voltage terminal) with the CT arrow pointing toward the load (away from the grid). Unlatch the CT and place Line 2 in through the opening. Latch the CT and listen for the click as it closes.

Extend Consumption CT Leads, If Needed

If needed, an electrician may extend the leads of the consumption CTs using the following guidance:



WARNING! To extend the CT leads, the electrician must use appropriately rated, 18-14 AWG, twisted pair wire and install it in accordance with all applicable local electrical codes and the National Electrical Code (NEC; NFPA 70).

The electrician may add as much as three ohms round trip resistance to the consumption CT or up to 1.5 ohms per wire. For reference, using NEC chapter 9 table 8 resistances, the following maximum lengths at 75° C by gauge are:

- 57.6 meters (189 feet) of 18AWG 7 strand Cu = 1.5 ohms
- 91.7 meters (301 feet) of 16AWG 7 strand Cu = 1.5 ohms
- 148.4 meters (478 feet) of 14AWG 7 strand Cu = 1.5 ohms



NOTE: In the NEC standard, chapter 9 table 8 resistance figures may not be appropriate for all geographies or installation conditions. A licensed electrician should determine the wire gauge and type to obtain a maximum round trip resistance of three ohms.

Select wire that is Code type, NRTL certified, and rated for voltage and temperature for the specific application. Mechanically protect the wires in a Code type, NRTL certified conduit or raceway. Use NRTL certified connectors for splices and insulated splices from one another and from the raceway, conduit, or junction box, if metallic.

Buried wires must be NRTL certified for direct burial and follow the Code for installation. Do not bury splices unless in a NRTL certified junction box rated for the application, and use an NRTL certified moisture resistant connection method.

4. Energize the Envoy-S

- a. Close the terminal block door, and secure it with the screw.
- b. Turn on the circuit feeding the Envoy-S.
- c. All four LEDs flash amber during boot up. This typically takes 2 to 3 minutes. When boot up is complete, the Device Communications LED  flashes amber indicating that microinverters are not yet detected.

5. Detect the Microinverters

Use one of the following methods to detect microinverters.

Method A: Provision Microinverters with Installer Toolkit

Use the Installer Toolkit mobile app to configure the Envoy-S with the serial numbers of the installed microinverters.

- a. Launch Installer Toolkit and tap **View Systems**.
- b. Select the system you are working with, or tap **[+]** to add a system.
- c. Connect to the Envoy-S with your mobile device as described in the side note.
- d. Return to Installer Toolkit. If the serial number for the Envoy-S you are installing is not displayed on the System Overview screen, tap the **[+]** next to the word **Envoys**. When the app displays the serial number of the Envoy-S, tap it to add it to the system.
- e. Following the on-screen instructions, use the Installer Toolkit app to create the arrays and scan the serial numbers from the installation map.
- f. Tap the **Connect** button. This provisions the scanned microinverters on the Envoy-S.
- g. When prompted, confirm the number of microinverters that you installed.
- h. If your system is in Hawaii or in another region that does not use the **Factory-Installed Grid Profile**, select and apply a grid profile to the microinverters.

The Device Communications LED  lights solid green when all of the provisioned devices are communicating or solid amber if any devices are not communicating.

Method B: Discover Microinverters with Installer Toolkit

- a. Use the Installer Toolkit mobile app to set the number of microinverters the Envoy-S should search for on the power line.
- b. Connect to the Envoy-S with your mobile device as described in the side note.
- c. Launch Installer Toolkit and tap **Connect to an Envoy**.
- d. When prompted, enter the number of microinverters that you installed.
- e. If your system is in Hawaii or in another region that does not use the **Factory-Installed Grid Profile**, select and apply a grid profile to the microinverters.
- f. When prompted to start a device scan, tap **OK**.

The Device Communications LED  flashes green while scanning. It lights solid green when all of the microinverters you installed are communicating or solid amber if any devices are not communicating.

Connecting to Envoy-S with a Mobile Device:

The Envoy's AP (Access Point) Wi-Fi network allows you to connect your mobile device to the Envoy-S. The AP Mode LED  lights solid green when the network is available.

- On the Envoy-S, if the AP Mode LED  is not lit, press the AP Mode button.
- On your mobile device, go to Settings and join the Wi-Fi network "Envoy_#####" (where "#####" represents the final six digits of the Envoy serial number).

Method C: Discover Microinverters with the Envoy-S

If you are not using the Installer Toolkit app, press the **Device Scan** button on the Envoy-S. With this method, the Envoy searches the power line for 15 minutes, but does not know how many microinverters it should discover.

The Device Communications LED  flashes green for 15 minutes while scanning. At the end of the scan, it lights solid green if at least one microinverter was discovered or solid amber if no microinverters were discovered (or if any discovered microinverter stops communicating).

With All Methods

If the Device Communications LED  remains solid, see “Microinverter Detection Issues” on page 36.



6. Verify System Configuration

While still connected to Envoy-S with Installer Toolkit, check the Overview screen for the following:



WARNING! If using consumption metering, be sure to set the meter type correctly. You cannot change this setting once the meter is enabled.

- a. Confirm that the expected number of devices are discovered and communicating.
- b. On the Overview screen, check that the grid profile is set on all the microinverters. This may take up to 5 minutes.
- c. Set up metering **for the Envoy-S Metered (model ENV-S-AM1-120 only)**:
- d. Tap the **Meters** button. If there is a check next to **Production Meter**, the production meter is enabled. If a gear  is shown, you must enable the meter:
- e. Tap **Production Meter**, and follow the on-screen instructions to enable the Production Meter.
- f. If you installed a consumption metering CT, tap **Consumption Meter** to enable the meter and follow the on-screen instructions to enable the Consumption Meter.
- g. Based on where you installed the consumption CT, indicate whether the circuit that passes through the consumption CT includes:
 - Load with solar production (also known as net) or
 - Load only (also known as total or gross), for example, in the case of a line-side tap.

If you used Installer Toolkit to detect microinverters, the Power Production LED  lights solid green when all expected microinverters are producing power. If you did not use Installer Toolkit, it lights solid green if all communicating microinverters are producing power. It flashes green when microinverters are upgrading. Check Installer Toolkit for production status details. If the Power Production LED  remains solid amber, see “Issue: Installer Toolkit Indicates that Scanning is Inhibited” on page 37.

7. Connect to Enlighten

The Envoy-S requires a connection to the Internet for reporting to Enlighten. You can provide this connection through an existing broadband router, other Wi-Fi access point at the installation site, or by using the Enphase Mobile Connect cellular modem.



WARNING! Risk of Equipment Damage. Do not remove power from the Envoy-S if the LEDs are flashing green. This indicates that a software update is in progress.

Connect to a broadband router using one of these methods, described in the following sections:

- Method A: Integrated Wi-Fi
- Method B: Enphase Mobile Connect (order CELLMODEM-01 separately)
- Method C: Ethernet cable (not included, installer must provide). This method requires that you use the ferrite bead included with the Envoy-S.
- Method D: Power Line Communication Bridges (order EPLC-01 separately). This method requires that you use the ferrite bead included with the Envoy-S.



Method A: Integrated Wi-Fi

The Envoy-S integrated Wi-Fi operates at both 2.4GHz and 5GHz and supports several wireless security protocols in addition to Wi-Fi WPS. These include WEP Open System, WEP Shared Key, WPA-PSK, WPA2-PSK, WPA-EAP, and WPA2-EAP. To use the Enphase integrated Wi-Fi, you need a wireless router.



- a. On the Envoy-S, verify that no Ethernet cable is plugged into the RJ45 port.
- b. If your router supports WPS, press and hold the WPS button on the wireless router for a few seconds. On most routers, a WPS LED begins flashing.
- c. If you are using the Installer Toolkit mobile app, tap the **Network** button, tap **Wi-Fi**, and find and select your network. If the wireless router does not support WPS, you may be prompted to enter a password.

If you are not using the Installer Toolkit mobile app, you can only connect using WPS. Initiate a WPS connection by pressing and holding the **AP Mode** button for 5 seconds.

The Network Communications LED  begins flashing green. Within three minutes the Network Communications LED  lights solid green, indicating a successful connection to the Internet and to Enlighten. If the Network Communications LED  remains off or lights solid amber, see “Internet Connection Issues” on page 38.

Method B: Enphase Mobile Connect Modem

Order CELLMODEM-01 separately.

To install Enphase Mobile Connect:

- a. Connect the antenna to the antenna connector (marked **CELL**) on the modem.
- b. Mount the modem as described in the *Enphase Mobile Connect Installation Guide*.
- c. Connect the micro-USB cable to the modem and connect the other end of the cable to the Envoy-S. If receiving power from the Envoy-S, the modem power LED lights up.

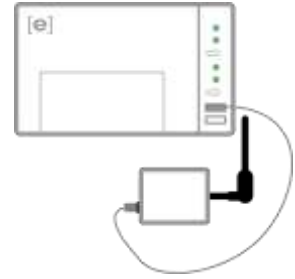

Within three minutes the Envoy-S Network Communications LED  lights solid green, indicating a successful connection to the Internet and to Enlighten.



NOTE: With Mobile Connect, the Envoy initially reports to Enlighten every five minutes for 12 hours or until the Envoy-S detects the expected number of microinverters, which is based on the number entered in **Total Number of PV Modules** in Enlighten. After that, the Envoy uses low bandwidth reporting mode. Low bandwidth mode reports 15-minute interval readings and event data to Enlighten four times a day rather than every 15 minutes as with other connection methods.

Method C: Ethernet Cable

To use this method, you need an Ethernet cable and a broadband router. The Enphase Envoy-S comes packaged with a ferrite bead. You must attach this ferrite bead to your Ethernet cable to ensure there is no communication interference between the Envoy-S and other devices. To install the cable and ferrite bead:

- a. Select a Cat5E or Cat6 Ethernet cable unshielded twisted pair (UTP). Do not use shielded twisted pair (STP) cable.
- b. Place the bead on the new cable, near one end, and close the latch.
- c. Plug the cable end with the ferrite bead into the Envoy-S Ethernet port.
- d. Secure a tie wrap on the cable on each side of the ferrite bead.
- e. Tighten an additional tie wrap around the ferrite bead.
- f. Trim any tie wrap excess.
- g. Plug the other end of the Ethernet cable into the network.

Within two minutes the Network Communications LED  lights solid green, indicating a successful connection to the Internet and to Enlighten.

When you use an Ethernet cable to connect to the LAN, two small LEDs on the Ethernet port indicate Ethernet link and activity. When the cable is connected correctly, the link LED lights solid green and the activity LED flashes green or yellow when data is sent or received.

Method D: Power Line Communication Bridges

Order EPLC-01 separately.

If you need to locate the Envoy-S away from the router, at a distance where an Ethernet cable is not practical or the wireless signal does not reach, use power line communication bridges with the Envoy-S. Bridges allow the Envoy-S to communicate with the broadband router over the site's power lines.

To install power line communication bridges:

- a. Plug one of the bridges into the same AC outlet as the Envoy-S.
- b. Place the bead on the cable, near one end, and close the latch.
- c. Plug the cable end with the ferrite bead into the Envoy-S Ethernet port.
- d. Secure a tie wrap on the cable on each side of the ferrite bead.
- e. Tighten an additional tie wrap around the ferrite bead.
- f. Trim any tie wrap excess.
- g. Plug the other end of the Ethernet cable into the bridge.
- h. Plug the other bridge into an AC outlet near the broadband router.
- i. Connect one end of a second Ethernet cable to the second bridge, and connect the other end of the Ethernet cable to the broadband router.

Within two minutes the Network Communications LED  lights solid green, indicating a successful connection to the Internet and to Enlighten.

If the Internet Connection Fails

If the Envoy-S does not connect to the Internet within five to ten minutes after using any of these connection methods, see "Internet Connection Issues" on page 38.

8. Send System Summary Report

When you have completed your system setup, you can generate and email a summary report.

- a. From Installer Toolkit, tap **Done** in the upper-right corner of the screen to disconnect from the Envoy. Installer Toolkit will ask if you want to view a summary report.
- b. Tap **View Report**. The report displays Envoy and system information with a list of microinverter serial numbers, their last power reports, and information about the grid profile applied to the microinverters.
- c. Tap  to email the report to your office as a record of successful system installation or to the utility for evidence of grid profile settings.



NOTE: If your mobile device is connected to the Envoy using AP mode, the email stays in the email app's outbox to be sent when the mobile device reconnects to the Internet. To disconnect from the Envoy network, go to Settings on your mobile device and disconnect from the Envoy-S Wi-Fi network "Envoy_nnnnnn" (where "nnnnnn" represents the final six digits of the Envoy serial number).



NOTE: If you connect to an Envoy after associating it to a system, the report includes a system name and address.

Activate Monitoring

Register the Envoy-S for monitoring of Enphase Microinverters in Enlighten at enlighten.enphaseenergy.com. Once you have registered the system and successfully installed the Envoy-S, Enlighten generates an account for the site owner. When you complete the registration and installation, Enphase sends account information to the site owner allowing them to log in to the Enlighten website and view system performance.

Method A: If the Envoy-S is Associated with a System in Installer Toolkit

- a. On your mobile device, go to your Wi-Fi settings and disconnect from the Envoy’s AP network. This should restore Internet connectivity to your device.
- b. Return to the Installer Toolkit app and tap the **Sync** button on the System Overview screen.
- c. Log in to Enlighten and click on the system activation’s name from the installer dashboard.
- d. From the activation form, open Array Builder. To see the Array Builder demo, go to enphase.com/support/videos.
 - If you used Installer Toolkit to build arrays and scan microinverter serial numbers, the array(s) are built. Make any necessary adjustments in Array Builder.
 - If you did NOT use Installer Toolkit to build arrays and scan microinverter serial numbers, create the virtual array in Array Builder using the installation map as your reference. (You may need to wait if the microinverters have not yet reported to Enlighten.)

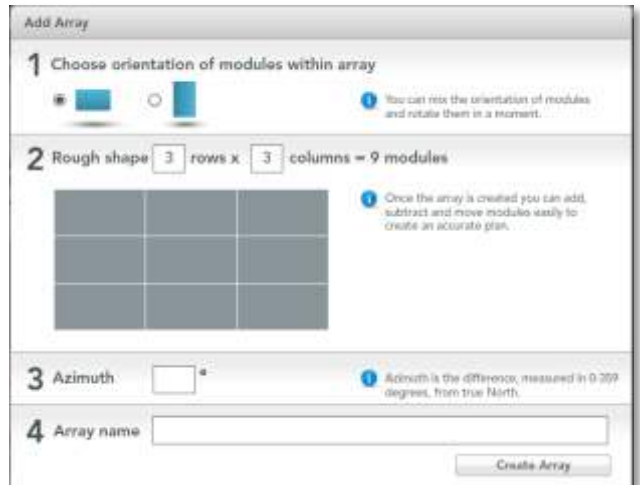

Method B: If the Envoy-S is NOT associated with a System in Installer Toolkit

- a. Log into Enlighten and click **Add a New System** from the installer dashboard.
- b. Enter the System, Installer, Owner, and Location information.
- c. Enter the Envoy serial number.
- d. Click **Save** to submit the form.
- e. After the microinverters have reported to Enlighten, open Array Builder from the activation form, and create the virtual array, using the installation map as your reference. To see the Array Builder demo, go to enphase.com/support/videos.

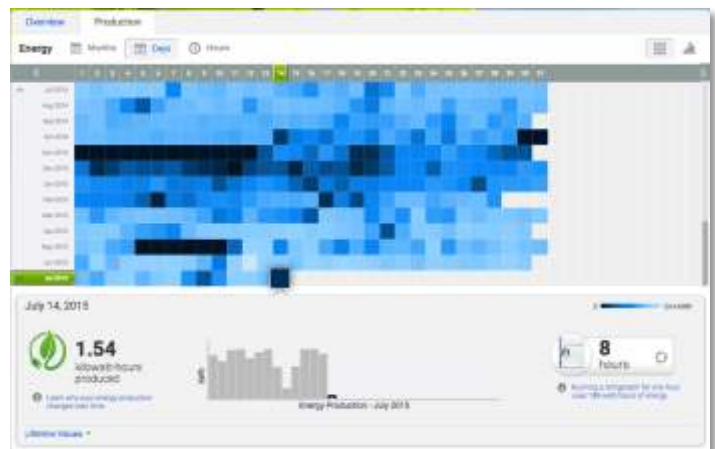







View System Performance in Enlighten

Once the array is built and the system is activated, you can log in to Enlighten to view site data. Enlighten displays a graphic representation of the PV system. It also shows detailed current and historical performance information.





Envoy-S Operation

Envoy-S Displays and Controls

You can track system installation progress with the Enphase Installer Toolkit mobile app. The LEDs on the Envoy-S are solid green when a function is enabled or performing as expected, flashing when an operation is in progress, or solid amber when troubleshooting with Installer Toolkit is required.

-  — **Network Communications LED:** Green when Envoy-S is connected to Enlighten.
-  — **AP Mode LED:** Green when Envoy’s AP Wi-Fi network is available.
-  — **AP Mode Button:** Press to enable Envoy’s AP Mode for connecting with a mobile device. Hold for 5 seconds to start WPS connection to a router.
-  — **Power Production LED:** Green when microinverters are producing power.
-  — **Device Communications LED:** Green when microinverters are communicating with Envoy-S.
-  — **Device Scan Button:** Press to start/stop a 15-minute scan for microinverters over the power line.

Envoy-S LED States

LED	State	Description
All	Flashing amber in unison	The Envoy-S is booting up
	Flashing green sequentially	Software update in progress
Network Communications 	Solid green	Communicating with Enlighten
	Flashing green	WPS connection in progress or the Envoy-S is attempting to connect to Enlighten
	Solid amber	Local network connection only
	Off	No network connection
AP mode 	Solid green	AP mode enabled: Envoy Wi-Fi network available
	Off	AP mode disabled: Envoy Wi-Fi network unavailable
Power production 	Solid green	All communicating microinverters are producing
	Flashing green	Microinverter update in progress
	Solid Amber	At least one microinverter is not producing
	Off	Microinverters are not communicating (low light or night time)
Device Communications 	Solid Green	All microinverters are communicating
	Flashing Green	Device scan in progress
	Solid Amber	At least one microinverter is not communicating
	Off	Microinverters are not communicating (low light or night time)

LED Behavior at Initial Start Up

When the Envoy-S starts up for the first time, it goes through the initial boot sequence. During this initial boot sequence, all the Envoy-S LEDs flash amber. Soon after connecting to the Internet, the Envoy-S may retrieve a software update, and the LEDs flash green sequentially during the update.



WARNING! Risk of Equipment Damage. Do not remove power from the Envoy-S if the LEDs are flashing green sequentially. This indicates that a software update is in progress.



Initial Communications Check

The Envoy-S normally indicates no Internet connection for two to three minutes after the first start up. It then sends the first report to Enlighten. When Enlighten responds, the Network Communications LED  lights solid green, indicating an Internet connection to Enlighten.

More about Device Communications States

A detected device (microinverter or battery) is one that has been discovered via the Envoy's device scan or provisioned via Installer Toolkit or Enlighten.

The states of the Device Communications LED  have slightly different meanings, depending on whether the installer has provided an expected number of microinverters. If you have NOT provided the expected number of microinverters either through the Activation form or in Installer Toolkit, the LED displays as described in the **No expected number provided** column. If you have provided the expected number of microinverters in the Activation form or in Installer Toolkit, this LED displays as described in the **Expected number provided** column. If the Envoy has been provisioned with the serial numbers of the microinverters, this displays as described in the **With provisioning** column.

State	No expected number provided	Expected number provided	With provisioning
Solid Green 	All discovered devices are communicating.	The expected number of devices was discovered and all are communicating.	All of the provisioned devices are communicating.
Solid Amber 	At least one of the discovered devices is not communicating.	The number of devices communicating is not equal to the number expected (e.g., 0/12, 1/12, 11/12, or 13/12).	The devices that are communicating are not the same as those provisioned.

Initiate a New Scan for Microinverters

The Envoy-S identifies each device by its unique serial number. If you add more microinverters to an existing system or replace a microinverter or the Envoy-S, you can run a scan to detect the new devices. To initiate a scan after you add new microinverters to an existing Enphase system, perform the following steps.

1. Press the **Device Scan** button. The Envoy-S begins a 15-minute scan to identify all of the microinverters deployed at the site. The Device Communications LED  flashes green during the scan. Alternatively, you can initiate a scan using Installer Toolkit.
2. Log into Enlighten to check for the new microinverter, and use Array Builder to add the new microinverter to the virtual array.
3. After the microinverter is detected, it is best to disable the scan. To do this, press the Envoy-S **Device Scan** button again.

Connecting to Envoy-S

There are several ways to connect with the Envoy-S to check status or do configuration tasks:

- Connect wirelessly using Installer Toolkit
- Connect remotely using Enlighten
- Connect using a computer or mobile device with the Envoy-S local interface

Connect Using the Installer Toolkit App

The Enphase Installer Toolkit is a mobile app that provides installers with onsite system configuration capabilities.

Options for establishing a connection between the Installer Toolkit app and the Envoy-S are:

- Connect the mobile device to the same LAN as the Envoy-S using the site's wireless router.
- Use the Envoy-S to create a wireless Access Point (AP).

Method A: Use the Site's Wireless Router to Connect to the Envoy-S

To use the site's wireless router, select **Settings** on your mobile device and then select **Wi-Fi**. Tap the network you want to join from the list of available networks.

Method B: Create a Wireless Access Point

You can connect to the Envoy-S without using the onsite router by creating a wireless Access Point (AP). Use the built-in Wi-Fi functionality to do this. AP mode supports use of a mobile device and times out after eight hours. The AP Mode LED  lights solid green when AP mode is active. AP Mode allows you to connect the Envoy-S to Installer Toolkit so that you can track system installation progress.

To start an AP session:

1. Briefly press the AP Mode button to start an 8-hour AP session on the Envoy-S. The AP Mode LED  lights solid green when AP mode is active.

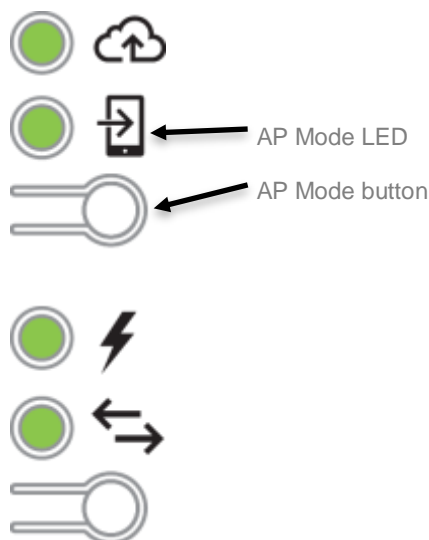

2. The AP Mode LED  remains solid green when AP mode is enabled and active. AP mode times out after eight hours. This LED is usually off during normal Envoy-S operation.

3. Select Settings on your mobile device and then select Wi-Fi. Tap “ENVOY_#####” (where “#####” represents the final six digits of the Envoy serial number) from the list of available networks.

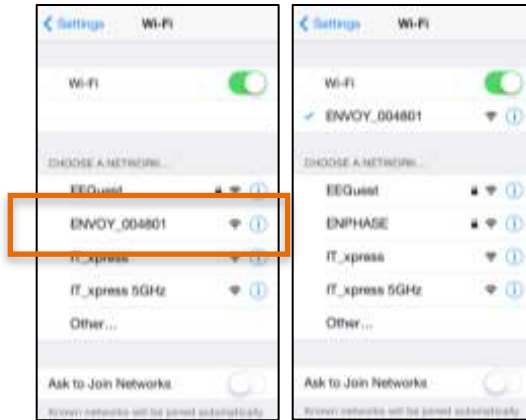

Complete the Connection to Envoy-S with Installer Toolkit

Once your mobile device and the Envoy are on the same LAN, you can connect to the Envoy-S.

1. Tap anywhere on the row containing the Envoy serial number or tap **Connect** at the bottom of the System Overview screen.



2. If you used the Installer Toolkit scanning tool to scan microinverters, this screen displays the names of the arrays and the number of microinverters associated with each array. Tap **Connect to Envoy**. The Installer Toolkit automatically attempts to connect to the Envoy.

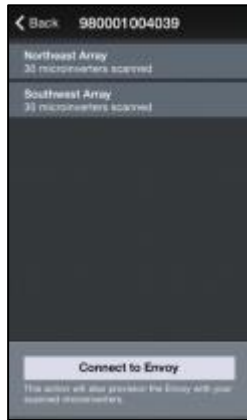

NOTE: If you used the Installer Toolkit scanning tool, the scanned microinverters are provisioned on the Envoy when you tap **Connect to Envoy**. This action also stops the device scan on the Envoy-S, if one is in progress.

Refer to enphase.com/installer-toolkit/ for more information on the Enphase Installer Toolkit.

Connect Remotely Using Enlighten

To check status of Enphase equipment, do the following:

1. Log on to Enlighten to view the array. Click **Devices**.
2. A list of equipment appears including the Envoy(s) and all of the microinverters that the Envoy has detected. The column on the far right lists the status of each microinverter.
3. To view status information for the Envoy, click the Envoy serial number.

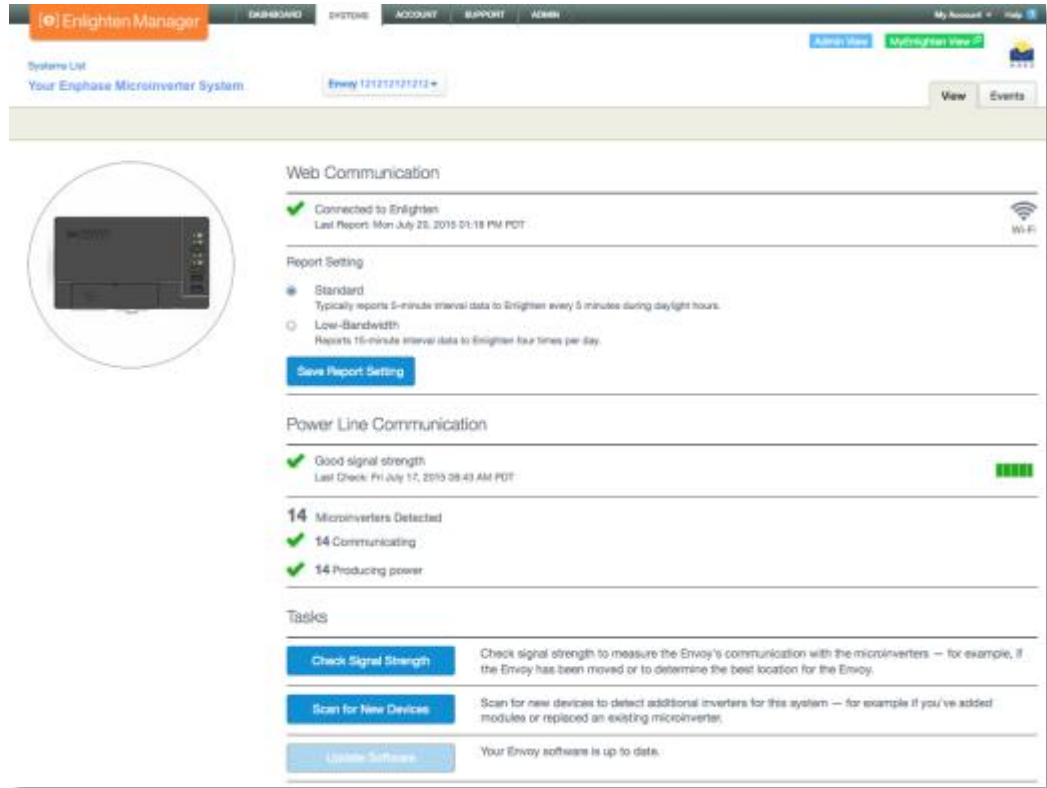

4. This screen indicates status for web communication, power line communication and microinverter count.
5. Check the report setting. The Envoy sends regular reports to Enlighten over the Internet connection. The default reporting mode for the Envoy-S is **Standard** (high-bandwidth). If the site uses the Enphase Mobile Connect modem, this setting is locked to **Low-Bandwidth**. Low bandwidth mode reports 15-minute interval readings and event data to Enlighten four times a day. Standard reporting sends five-minute interval data to Enlighten every five minutes during daylight hours. The Enlighten view is refreshed every 15 minutes.
6. From here you can choose to **Check Signal Strength** or **Rescan for Devices** as needed. When checking signal strength, allow up to 15 minutes for a response.
7. If the text to the right of the Update Software indicates that the Envoy-S requires an update, click **Update Software** and follow the prompts.

The Envoy-S relays data to Enlighten using an Internet connection. However, even if there is no active Internet connection, you can communicate directly with the Envoy-S using the Ethernet port and a personal computer or mobile device with a web browser. Options for connecting to the Envoy local interface are:

Connect Using the Envoy-S Local Interface

With your computer or mobile device connected to the same LAN (local area network) as the Envoy-S, you can access the Envoy-S interface.

1. Use the Envoy's built-in Wi-Fi or connect an Ethernet cable between a computer and the Envoy-S.
2. Open an Internet browser application on a computer or mobile device connected to the same LAN as the Envoy-S.
3. In the browser address window, enter **http://envoy.local** to view system details and status. (When there is no broadband router in the network, connect a laptop directly to the Envoy-S Ethernet port using an Ethernet cable and browse to **169.254.120.**)

If there are additional Envoy-S units on the network, you can access them by entering the following strings in the browser window:

- http://envoy-2.local
- http://envoy-3.local, and so on

Once the browser has successfully connected with the Envoy-S, the home screen is displayed in the browser window.

View Production Readings

The production readings at the top of the pane show current and lifetime production values. The first value shows today's production, while the second shows the total production for the lifetime of the system.

- If your system uses an Envoy-S, Metered gateway, it displays production meter readings. You can also view production as reported by the microinverters by selecting the arrow to the left of the words **Microinverter Production**.
- If your system uses an Envoy-S, Standard gateway, the system displays production values reported by the microinverters.

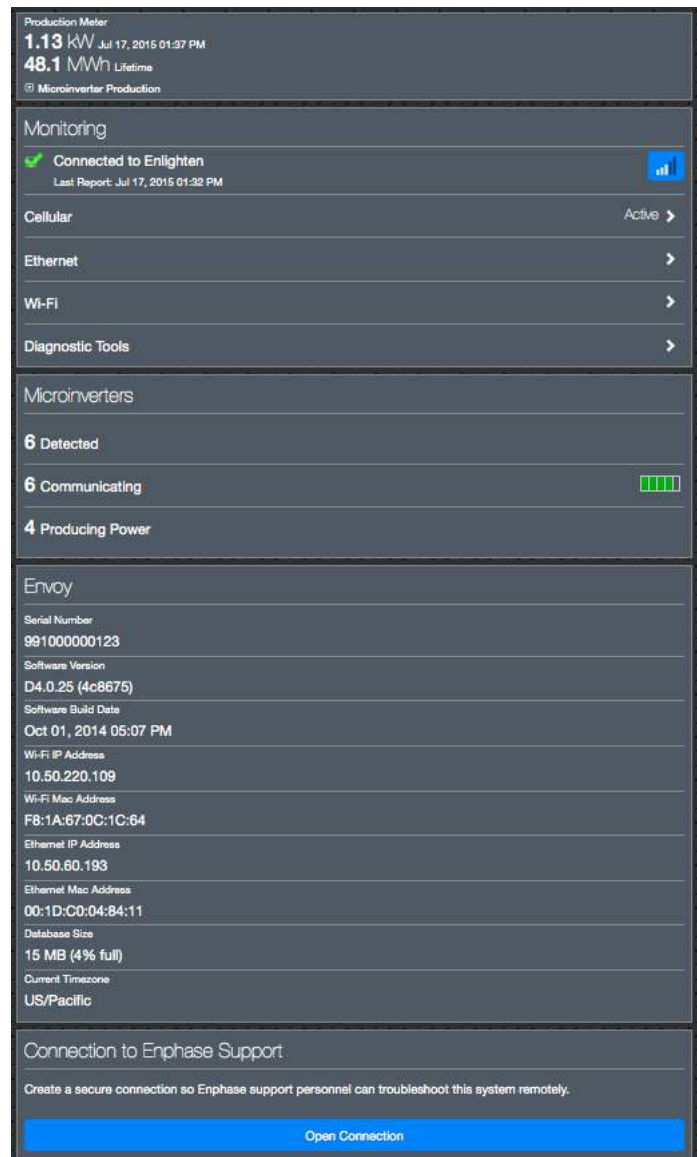

View or Change Monitoring Settings

Under **Monitoring**, you can view web communication status.

To access the **Cellular**, **Wi-Fi**, **Ethernet** or **Diagnostic Tools** pages, select the > to the right of the desired page name. You will be prompted to enter the following login credentials:

- Username: envoy
- Password: nnnnnn (where nnnnnn are the last six digits of the Envoy-S serial number)

View Cellular Connection Information

When the Envoy-S uses the Mobile Connect modem to connect with Enlighten, select > to view Cellular Configuration information.

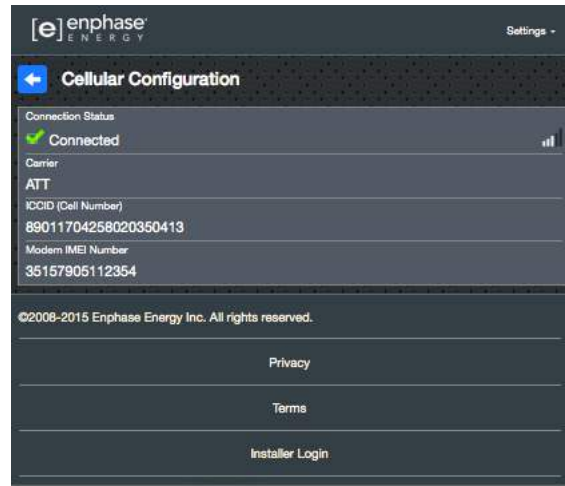

View or Change Ethernet Settings

When the Envoy uses Ethernet to connect with Enlighten, select > to view Ethernet configuration information. From here you can set up for static IP or reset the IP address, if needed.

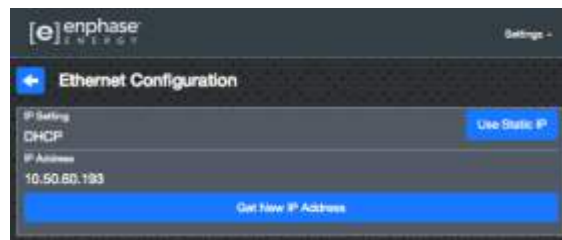

WARNING: Do not change the Envoy DHCP setting to use a static IP address unless you also reserve the same IP address on the broadband router. See the section on DHCP reservations in the router instructions. Failure to reserve the static IP address on the router may result in duplicate IP addresses and intermittent Internet connection problems with the Envoy.

- To use a static IP address, select **Use Static IP** and enter information as needed.
- Select **Update**. The application asks you to confirm: This may interrupt communications with the Envoy-S and require you to reconnect.
- Select **OK** to continue, or select **Cancel**.

View or Change Wi-Fi Settings

When the Envoy uses Wi-Fi to connect with Enlighten, select > to view Wi-Fi configuration information. From here you view Available Networks (WPS and AP), **Update Country**, **Enable AP Mode**, and view Device information.

If you replace the broadband router at the installation site, you need to update the connection information on the Envoy-S. To do this:

- Select **Connect Other Network**.
- Enter the new **Wireless Network Name (ESSID)** and **Security** code.

If you need to disconnect the Envoy from a Wi-Fi network:

- Select **More Info**.
- Click **Forget this Network**.

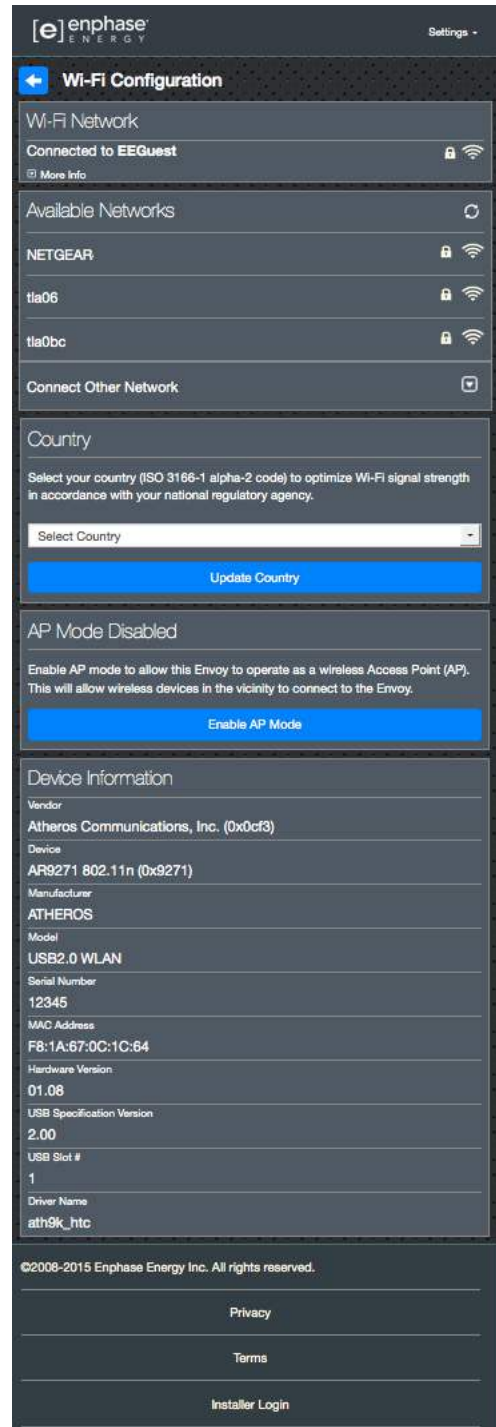

Diagnose Network Connection

Select **Diagnostic Tools** to ping the Envoy, check network connectivity, and check the network route.

Ping: To check that the router or network host connected to the Envoy:

- Select **Ping**.
- Enter the IP address or url for the router or network host.
The application displays a loading message until results are returned. If the router or network host is connected to the Envoy, the Ping returns a success message. If the router or network host is not connected to the Envoy, the Ping returns the following:
ping: bad address <xxx>

Check Network Connectivity: To check network connectivity details for the Envoy:

- Select **Check Network Connectivity**.
The application displays a loading message until results are returned. When the results return, the application displays a collection of basic network diagnostic checks and results for the Envoy.

Check Network Route: To see the Envoy's path to the Internet for all network interfaces:

- Select **Check Network Route**.
The application displays a loading message until results are returned. When the results return, the application displays a collection of routing details for the Envoy's path to the Internet.

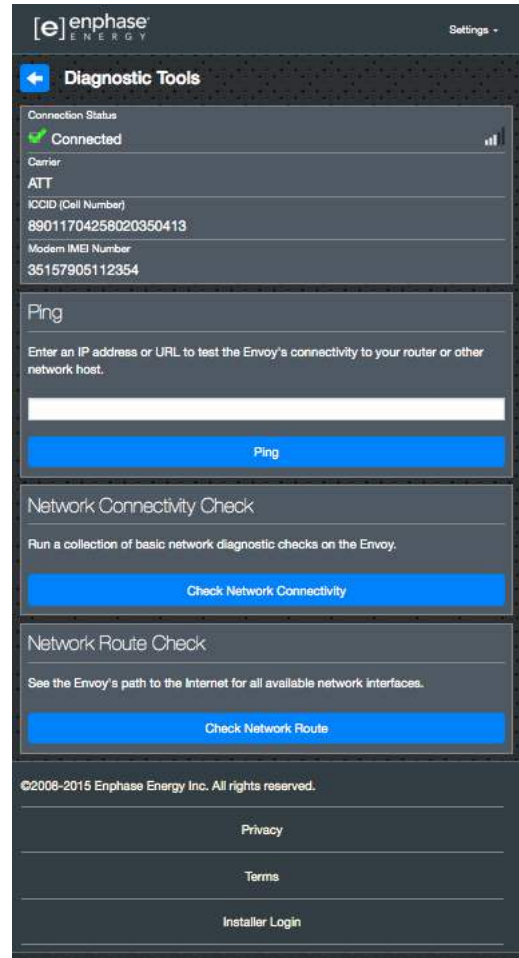

View Microinverter Information

Under **Microinverters**, the screen displays:

- The number to the left of the word **Detected** indicates the number of microinverters detected by this Envoy.
- The number to the left of the word **Communicating** indicates the number of microinverters communicating with this Envoy.
- The number to the left of the words **Producing Power** indicates the number of microinverters communicating with this Envoy.

View Envoy Information

Under **Envoy**, the screen lists the Envoy serial number, time zone, and connection information that varies depending on Internet connection type, and version information.

Open a Connection for Enphase Troubleshooting

Under **Connection to Enphase Support**, there is an option to open a connection to allow Enphase to perform remote troubleshooting

If you contact Enphase Customer Support, Enphase personnel may ask you to open a secure connection for diagnostic purposes.

- To open secure connection so Enphase support personnel can remotely troubleshoot this system, select **Open Connection**.
- To close the secure connection, select **Close Connection**.

Troubleshooting

The following sections describe possible problems and solutions.



WARNING: Risk of electric shock. Risk of fire. Do not attempt to repair the Envoy-S; it contains no user-serviceable parts. Tampering with or opening the Envoy-S will void the warranty. If the Envoy-S fails, contact Enphase Customer Support for assistance (enphase.com/en-us/support/contact). Warranty void if cover removed. Refer servicing to qualified personnel.

Microinverter Detection Issues

Troubleshoot power line communication issues as follows.

Issue: Installer Toolkit Shows “Cross Domain Traffic Reported”

This means that communications from other Envoy(s) have been detected. To prevent this issue:

- When multiple Envoy-S units exist on a common service panel or utility transformer, commission only one system at a time at installation.
- When multiple Envoy-S units on a common service panel, use power line filters and separate the conduits and wires by at least 32 centimeters (12 inches).

If this alert persists or if the Installer Toolkit Microinverters screen or Enlighten shows more microinverters than expected, contact Enphase Customer support at enphase.com/en-us/support/contact.

Issue: Device Communications LED is Solid Amber

If the Device Communications LED  lights solid amber, it may be a result of low light levels. If there is not enough sunlight to power up the microinverters, they cannot communicate with the Envoy. If there is sufficient daylight for the microinverters to power up, the Envoy may be having difficulty communicating over the power lines. To troubleshoot this issue:

- Check the Installer Toolkit mobile app to see which microinverters are not communicating.
- Check that the circuit breaker(s) for the PV array are in the **ON** position.
- Verify that the PV modules are connected to the microinverters.
- Verify the PV module DC voltage is within the allowable range for the microinverter.

Issue: Installer Toolkit Detects Fewer Microinverters than Expected

The **Microinverters detected** count is an indication of the number of online microinverters producing power, reporting in to the Envoy, and not having any error conditions. If this number is lower than expected, it may indicate that the Envoy is not done scanning/discovering the entire array. Alternatively, it may indicate that the Envoy is having difficulty communicating over the power lines. It could also be a result of low light levels or insufficient PV module voltage to power the microinverter. To troubleshoot the issue:

- Check Enlighten or use the Installer Toolkit to connect to the Envoy to see if any microinverters are not reporting in to the Envoy or having any error conditions.
- If installing the Envoy-S Standard, be sure that the Envoy is plugged directly into the wall and **not** into a power strip or surge protector. Unplug any other device sharing the outlet with the Envoy.
- Alternatively, plug the Envoy into a circuit that supports fewer electronic appliances. Appliances sharing a power receptacle with the Envoy may interfere with power line communication.
- Relocate your Envoy as close to the AC mains as possible. This ensures that the Envoy receives the strongest possible signal from each microinverter.
- If this problem occurs when light levels are low, try again during daylight hours.

Issue: No Microinverters are Reporting

Check for the following conditions.

Has a device scan been run while the array was active? A device scan may have been run while the array was not connected to the grid or when the array was not powered by sunlight.

- Run another scan during daylight hours.
- Check that the circuit breaker(s) for the PV array are in the **ON** position. For the Envoy to communicate with the microinverters, the PV circuit breakers must be in the **ON** position in the electrical load center.
- Verify that the PV modules are connected to the microinverters.

Is the Envoy well located? The Envoy must be near the primary load center or the array's downstream subpanel. If installing the Envoy-S Standard:

- Make sure the Envoy is not plugged into an outlet strip or surge protector.
- Plug the Envoy into an outlet closer to the main load center or subpanel.
- Unplug other devices from the AC outlet used for the Envoy.
- If signal strength is poor, power the Envoy from the solar production circuit (where local electrical code allows for monitoring equipment on the same circuit). This provides the best possible power line communications. The Envoy must be located indoors (a garage, attic, basement, or other cool, dry location) or in an NRTL-certified, NEMA type 3R enclosure. Remember that the Envoy must also have an Internet connection.

Is the system energized? PV modules power microinverters, PV modules provide power only during daylight hours, and microinverters communicate only when powered.

- Run another scan during daylight hours.
- Check that the circuit breaker(s) for the PV array are in the **ON** position. For the Envoy to communicate with the microinverters, the PV circuit breakers must be in the **ON** position in the electrical load center.
- Verify that the PV modules are connected to the microinverters.

Is there a phase imbalance?

- Ask the electrician to measure the conductors and neutral line to verify that the phases are balanced. If the phases are not balanced, electricians must recheck the wiring.

Is the Envoy-S plugged into a circuit on the primary load center while the PV circuit breakers are on a downstream subpanel? The primary load center is full and doesn't have additional capacity to add circuit breakers.

- Add a subpanel with a small subset of circuit breakers
- Hard wire the Envoy-S into that subpanel, so that it can be close to the PV circuit breaker.

Issue: Installer Toolkit Indicates that Scanning is Inhibited

It is best to leave the Envoy in this condition for normal operation. However, if you need to re-enable scanning (for example, if you replace a microinverter) contact Enphase Customer Support at enphase.com/en-us/support/contact.

Power Production Issues

Issue: Power Production LED is solid amber

The Power Production LED  is solid green when all microinverters are producing, flashes green when a microinverter update is in progress, flashes amber when microinverters are not yet detected, or becomes solid amber when any microinverter that is expected to produce does not. Use Installer Toolkit to see which microinverters are affected.

- If none of the microinverters are producing power, there may be a grid or wiring issue. First, verify that there is proper input voltage and frequency from the grid. Next, check the breaker and wiring starting at the load center.
- If all of the non-productive microinverters are on the same branch, check the breaker and wiring starting at the junction box for the affected branch.
- If only one or scattered microinverters are not producing power, first check to see that the AC connectors are fully seated in the Engage Cable connectors. Next, check that each module is meeting the required start-up voltage for the microinverter (usually 22 V). A PV module that is failing or that is undersized may not generate enough power for AC conversion.
- Microinverters will not report production if they are not communicating with the Envoy-S. Refer to “Microinverter Detection Issues” on page 36 for troubleshooting steps.

Internet Connection Issues

To the Local Area Network (LAN), the Envoy is just another host on the network, much like a personal computer. Enphase offers technical support at enphase.com/en-us/support/contact for Envoy issues, but Enphase's Support responsibility does not extend to the premises network or LAN.

The Envoy must obtain a DHCP (Dynamic Host Configuration Protocol) IP address and have a route to the Internet. The Envoy will request this IP address from the broadband router during the power-up sequence. Two small green LEDs on the Ethernet port indicate Internet link and activity. During the sequence, one LED will be solid green, and the other will blink every few seconds.

Issue: Network Communications LED is Amber or Off

The Envoy-S is configured to perform a DHCP broadcast when it first boots up, and requests an IP address from a DHCP source. This source can be a server/computer, but almost all consumer-grade broadband routers also provide DHCP services. When the Network Communications LED  is solid amber, the Envoy-S has a local network connection only and failed to connect to Enlighten after its scheduled reporting time (five minutes). When the LED is off, there is no network connection.

If you are using the Enphase Mobile Connect modem and the Network Communications LED  remains off or lights solid amber, see Troubleshooting in the *Enphase Mobile Connect Installation Guide*.

For any connection method, you can troubleshoot network issues using the Installer Toolkit mobile app by tapping the **Network** button, then **Diagnostic Tools**.

- Allow 10 minutes after initial installation. If the Envoy has recently received a valid IP address, the LED will likely turn green momentarily.
- Check network connectivity to the router or other DHCP server. You may also wish to contact your Internet Service Provider or refer to your router documentation for help.
- Check that you are using a broadband router and not a switch or a hub. Many hubs and switches cannot provide a DHCP lease and may not allow the Envoy to connect to the web.
- Use the Installer Toolkit to **Get New IP Address**, and then allow 30 to 60 seconds for the Network Communications LED  to turn solid green.
- When the Envoy-S is connected to the LAN via Ethernet cable, two small LEDs on the Ethernet port indicate Internet link and activity. One LED will be solid green, and the other will blink green or yellow every few seconds. If either LED is neither on nor blinking, try using a new Ethernet (CAT5) cable in place of the existing cable.
- Power down all units in the chain, applying power again in this order: 1) modem, 2) router, and 3) Envoy. Allow a few minutes for the IP address to be reassigned.
- If you replace the broadband router, configure the Envoy Wi-Fi settings for the new wireless network name (SSID) and password.

Issue: Wi-Fi Problems

If the Network Communications LED  remains off:

- If the Envoy is installed in an enclosure, is the enclosure metallic? Metal enclosures may impede wireless communication.
- Stucco and plaster wall construction may contain metal mesh, which can affect wireless range. If you cannot see your router or access point in the list on the Envoy, or cannot maintain a connection, relocate the Envoy to be closer to your router or access point.
- The WPS connection window may have timed out. Retry the connection steps.
- Make sure that the broadband router is operational by checking that other devices at the site can access the network.
- If you cannot see your router or access point in the list on the Envoy, or cannot maintain a connection, it may be necessary to add a wireless repeater to extend the network range.

If the Network Communications LED  lights solid amber:

- Power down all units in the chain, applying power again in this order: 1) broadband modem, 2) router or Wi-Fi base station, and 3) Envoy.
- Make sure that the broadband router is connected to the Internet by checking that other devices at the site can access the Internet. If the other devices are not connected to the Internet, contact your ISP for assistance.

Issue: Cellular Modem Connection Status “Not Connected”

If the Envoy-S uses an Enphase Mobile Connect, the Envoy-S Network Communications LED is solid amber for longer than 12 hours, and the Installer Toolkit displays a Connection Status of **Not Connected**:

- Unplug the modem USB cable.
- Power cycle the Envoy-S, and wait until Envoy-S completely restarts.
- Re-connect the cellular modem USB cable.
- Allow two minutes between any extraction and insertion of the modem cable in the USB port of the cellular modem.

Issue: Envoy-S is not Connecting with a New Router

If you replace the broadband router at the installation, you need to update the connection information on the Envoy-S. To do this:

- Connect to the Envoy-S local interface as described on page 31.
- Select **Wi-Fi**.
- Select **Connect Other Network**.
- Enter the new **Wireless Network Name (ESSID)** and **Security** code.

Local Networking Considerations

DHCP versus Static IP Addressing

If the site owner prefers not to use DHCP, you can set up the Envoy to use a static IP address. Use the Installer Toolkit to configure the static IP. Refer to enphase.com/installer-toolkit/ for more information on the Enphase Installer Toolkit.

- Tap the **Network Connectivity** menu item. This allows you to see if the Envoy is using DHCP or Static-IP, and it allows you to change this setting if needed.
- Tap **Check Network Connectivity** to view the Envoy connections.



WARNING: Do not change the Envoy DHCP setting to use a static IP address unless you also reserve the same IP address on the broadband router. See the section on DHCP reservations in the router instructions. Failure to reserve the static IP address on the router may result in duplicate IP addresses and intermittent Internet connection problems with the Envoy-S.

MAC Filtering

Check to see if Media Access Control (MAC) filtering is in use at the site. An example of a MAC address would be: 00:17:F2:D6:B1:45

- MAC addresses contain six pairs of characters, including any number 0-9 and letters A-F.
- The MAC address of the Envoy will begin with 00:D0:69

If MAC filtering is in use at the site, identify the specific MAC address of the Envoy and add it to list of authorized devices on the router. The MAC addresses (wired and wireless) are located on a label on the back of the Envoy.

Firewall Settings

The Envoy initiates **outbound** connections to Internet servers. Such connections may be restricted by firewall rules set up on the site's broadband router. Broadband routers typically allow all outbound connections but restrict any/all inbound connections.

If outbound firewall rules are applied at the site, you must configure a static IP address for the Envoy and add new rules that allow outbound access as follows:

Direction	Source	Protocol	Port	Destination
OUT	<Envoy IP address>	TCP	80, 443	reports.enphaseenergy.com
OUT	<Envoy IP address>	UDP	80	ping-udp.enphaseenergy.com
OUT	<Envoy IP address>	TCP	80, 443	home.enphaseenergy.com

The Envoy connects to these servers using their DNS names. If you add firewall rules for Envoy reporting, Enphase recommends using the DNS names rather than the underlying IP addresses. This is because the IP addresses are subject to change without notice.

Microinverter Issues

Clear “DC Resistance Low - Power Off” Condition

This condition occurs only with the S-Series and M250 Microinverters and one model of the M215 Microinverter (M215-60-2LL-S22-IG). A solid red status LED on the microinverter indicates this condition. The LED will remain red and the fault will continue to be reported by the Envoy until the error has been cleared.

An insulation resistance (IR) sensor in the microinverter measures the resistance between the positive and negative PV inputs to ground. If either resistance drops below a threshold, the microinverter stops power production and raises this condition. This may indicate defective module insulation, defective wiring or connectors, moisture ingress, etc. Although the cause may be temporary, this microinverter condition persists until the sensor is manually reset.

If a microinverter registers a **DC Resistance Low - Power Off** condition, you can attempt to clear this condition. An Envoy is required to send the clear-dc-resistance-low message to clear the condition. If the condition does not clear after you perform the following procedure, contact Enphase Energy customer support at enphase.com/en-us/support/contact.



There are two ways to send a clear message to the microinverter. Note that the condition will not clear after sensor reset if the cause of the failure is still present. If the condition persists, contact your installer.

Method 1: Clear this error through Enlighten

- Access the System in Enlighten.
- Click the **Events** tab. The next screen shows that there is a current **DC Resistance Low - Power Off** condition for the system.
- Click **DC Resistance Low - Power Off**.
- Where “n” is the number of affected devices, click **n devices (show details)**.
- Click the serial number of the affected microinverter.
- Click the **Reset DC Resistance Low - Power Off Sensor** button.
The system displays, “A DC Resistance Low- Power Off reset task was issued on 08/03/2015 01:34 PM CDT for this microinverter and is still pending.”

Method 2: Send the clear message using Installer Toolkit

On the list of detected microinverters, a green dot or red square appears to the left of each microinverter serial number. A green dot indicates Status OK. A red square indicates an event for that microinverter.

- Tap the  to the left of the serial number to view details for a microinverter event.
- If the microinverter status shows that there is an active **DC Resistance Low – Power Off** condition, tap the  to send the clear message to the affected microinverter.

The app then indicates that a clear message was sent.

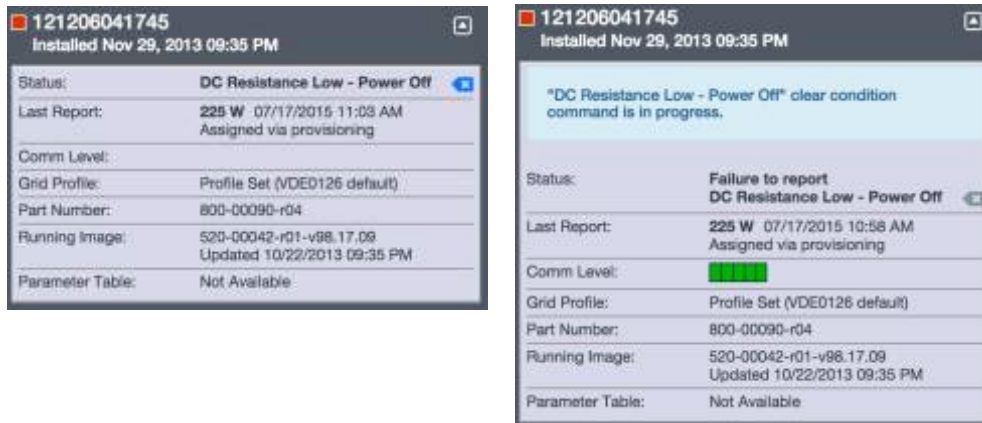

Clear “GFI Tripped” Condition

This condition occurs only with the M190, D380, M210, M200, M175 Microinverters and one model of the M215 Microinverter (M215-60-2LL-S22). A solid red status LED on the microinverter indicates a ground fault (GFDI) error. The LED will remain red and the fault will continue to be reported by the Envoy until the error has been cleared.

If a microinverter registers a **GFI Tripped** condition, you can attempt to clear this condition. An Envoy is required to send the clear-gfi message to clear the condition. If the condition does not clear after you perform the following procedure, contact Enphase Energy customer support at enphase.com/en-us/support/contact.



There are two ways to send a clear message to the microinverter. Note that the condition will not clear after sensor reset if the cause of the failure is still present.

Method 1: Clear this error through Enlighten

- Access the System in Enlighten.
- Click the **Events** tab. The next screen shows that there is a current **GFI Tripped** condition for the system.
- Click **GFI Tripped**.
- Where “n” is the number of affected devices, click **n devices (show details)**.
- Click the serial number of the affected microinverter.
- Click the **Reset GFI Sensor** button.
The system displays, “A GFI sensor reset task was issued on 08/03/2015 01:34 PM CDT for this microinverter and is still pending.”

Method 2: Send the clear message using Installer Toolkit

On the list of detected microinverters, a green dot or red square appears to the left of each microinverter serial number. A green dot indicates Status OK. A red square indicates an event for that microinverter.

- Tap the  to the left of the serial number to view details for a microinverter event.
- If the microinverter status shows that there is an active **GFI tripped** condition, tap the  to send the clear message to the affected microinverter.
The app then indicates that a clear message was sent.



Replacing an Envoy-S

If problems remain after following the troubleshooting steps above, contact Enphase at enphase.com/en-us/support/contact.



DANGER! Risk of electric shock. Risk of fire. Do not attempt to repair the Envoy-S; it contains no user-serviceable parts. Tampering with or opening the Envoy-S will void the warranty. If the Envoy-S fails, contact Enphase Customer Support for assistance at enphase.com/en-us/support/contact.

- Warranty void if cover removed.
- Refer servicing to qualified personnel.

If Enphase Customer Support authorizes an Envoy-S replacement (RMA), perform the following steps.



DANGER! Risk of electrocution! When replacing the Envoy-S Metered, CTs must be installed with no current flowing in the sensed circuit. Always install CT wires in the terminal blocks before energizing the sensed circuit. Always de-energize the sensed circuit before disconnecting the CT leads from the terminal block.



DANGER! Risk of electric shock. Be aware that installation of this equipment includes risk of electric **shock**. Always de-energize circuits before wiring for power and CTs.



DANGER! Risk of electric shock. Risk of fire. If the Envoy-S is wired for metering, only qualified personnel should install or replace the Enphase Envoy-S.



WARNING! When replacing the Envoy-S Metered, you must install a new production CT to maintain metering accuracy. A new production CT is included with the replacement Envoy-S.



WARNING! If the Envoy-S you are replacing uses an Enphase cellular modem (Enphase Mobile Connect), do NOT move the cellular modem to another installation site. This de-activates the modem.

Replacing an Envoy-S Standard (non-hardwired)

If Enphase Customer Support authorizes replacement (RMA) of an Envoy-S Standard (Model ENV-S-AB-120-A), perform the following steps.

1. Disconnect the Ethernet cable (if used) and power cord from the old Envoy-S.
2. When the replacement Envoy-S arrives, power it as described in “2. Provide a Power Connection” on page 13.
3. Verify that the new Envoy-S powers up.



NOTE: When powered up and connected for the first time, the Envoy-S may retrieve an automatic update from Enphase. This update may take up to 15 minutes. During update the Envoy-S LEDs flash green sequentially.

WARNING! Risk of Equipment Damage. Do not remove power from the Envoy-S if the LEDs are flashing green sequentially. This indicates that a software update is in progress.



WARNING: If the included power cord is missing or lost, you must use a UL listed junior hard service max three-foot cord with a NEMA configuration 1-15P plug, rated for a minimum of 125 VAC with a type IEC 60320-C7 connector.

4. Connect the Envoy-S to Enlighten as described in “7. Connect to Enlighten” on page 21.
5. Verify that the new Envoy-S Network Communications LED  lights green within five minutes. If not, follow the network troubleshooting steps on page 38.
6. If possible, log in to Enlighten and add the Envoy-S to the Activation for this system by clicking **Add Another Envoy** under the **Envoy** section.
7. Verify that the new Envoy-S starts discovering microinverters within 20 minutes of starting up. If necessary, use the Enlighten or Device Scan button to start a new device scan during daylight hours. (See “Initiate a New Scan for Microinverters” on page 26.)



NOTE: If the old Envoy-S has communicated to the microinverters on the same day that the new replacement Envoy-S is installed, the new Envoy-S will be unable to discover the microinverters. Contact Enphase at enphase.com/en-us/support/contact for assistance in this situation.

8. Assess the power line communications by running a Communication Check from Enlighten or the Installer Toolkit. If the communication check shows poor power line communications, relocate the Envoy-S closer to the load center.
9. Contact Enphase Support at enphase.com/en-us/support/contact to have the new Envoy-S added to your system and to retire the replaced Envoy-S.
10. Ship the old Envoy-S to Enphase using the supplied RMA shipping label.

Replacing a Hardwired Envoy-S

If Enphase Customer Support authorizes an Envoy-S replacement (RMA), perform the following steps.



DANGER! Risk of electrocution! CTs must be installed with no current flowing in the sensed circuit. Always install CT wires in the terminal blocks before energizing the sensed circuit. Do not disconnect the CT leads from the terminal block while the sensed circuit is energized.



DANGER! Risk of electric shock. Be aware that installation of this equipment includes risk of electric **shock**. If you wire the Envoy-S at the subpanel, always de-energize the subpanel before servicing.



WARNING! When replacing an Envoy-S that uses a production CT (model ENV-S-AM1-120), you must install the new production CT included with the replacement Envoy-S.

1. Turn off the circuit breaker supplying Envoy-S.
2. Disconnect the L1, L2, L3 (if used) and Neutral wires from the old Envoy.
3. Disconnect the Ethernet cable (if used).
4. Turn off the circuit breaker supplying the microinverters.
5. Unlatch the split-core of the production CT (if used) before disconnecting. Once the CT is unlatched, remove it from the sensed wires.
6. Unlatch the split-core of the consumption CTs (if used) before disconnecting. Once the CTs are unlatched, remove them from the sensed wires.
7. When the replacement Envoy-S arrives, install the Envoy-S and provide power as described in “2. Provide a Power Connection” on page 13.

8. Install the new production CT and consumption CTs (if used) as described in “3. Install CTs for Metering (Model ENV-S-AM1-120 only)” on page 16.
9. Verify that the new Envoy-S powers up.



BEST PRACTICE: When powered up and connected for the first time, the Envoy-S may retrieve an automatic update from Enphase. This update may take up to 15 minutes. During the update the Envoy-S LEDs flash green sequentially.



WARNING! Risk of Equipment Damage. Do not remove power from the Envoy-S if the Envoy-S LEDs are flashing green sequentially. This indicates that a software update is in progress.

10. Connect the Envoy-S to Enlighten as described in “7. Connect to Enlighten” on page 21.
11. Verify that the new Envoy-S Network Communications LED  lights green within five minutes. If not, follow the network troubleshooting steps on page 38.
12. If possible, log in to Enlighten and add the Envoy-S to the Activation for this system by clicking **Add Another Envoy** under the **Envoy** section.
13. Verify that the new Envoy-S starts discovering microinverters within 20 minutes of starting up. If necessary, use the Enlighten or Device Scan button to start a new device scan during daylight hours. (See “Initiate a New Scan for Microinverters” on page 26.)



NOTE: If the old Envoy-S has communicated to the microinverters on the same day that the new replacement Envoy-S is installed, the new Envoy-S will be unable to discover the microinverters. Contact Enphase at enphase.com/en-us/support/contact for assistance in this situation.

14. Assess the power line communications by running a Communication Check from Enlighten or the Installer Toolkit. If the communication check shows poor power line communications, relocate the Envoy-S closer to the load center.
15. Contact Enphase Support at enphase.com/en-us/support/contact to have the new Envoy-S added to your system and to retire the replaced Envoy-S.
16. Ship the old Envoy-S to Enphase using the supplied RMA shipping label.

Technical Data

Model Numbers	
Envoy-S, Standard ENV-S-AB-120-A	Enphase Envoy-S communications gateway with standard PV production monitoring (+/- 5%).
Envoy-S, Metered ENV-S-AM1-120	Enphase Envoy-S communications gateway with integrated revenue grade PV production metering (ANSI C12.20 +/- 0.5%) and optional consumption monitoring (+/- 2.5%).
Accessories (order separately)	
Enphase Mobile Connect CELLMODEM-01	Plug and play industrial grade cellular modem with five-year data plan for systems up to 60 microinverters. (Available where there is adequate cellular service in the installation area.)
Consumption Monitoring CT CT-200-SPLIT	For use with ENV-S-AM1-120, split-core current transformers enable whole home consumption metering (+/- 2.5%).
Wire / Power Requirements / Power Specifications	
Cord connected	120 VAC, 60 Hz (ENV-S-AB-120-A) Max 15 A overcurrent protection required. 120 VAC L-N, 0.22 A, 60 Hz, OVC III
Hard-wired to subpanel	120 VAC, 60 Hz (ENV-S-AB-120-A) 120/240 VAC split-phase (ENV-S-AM1-120) 120 VAC or 120/240 VAC or 208Y/120 VAC, 0.22 A, 60 Hz, OVC III. When hard wired and installed in an enclosure, the supply wiring must be 14 AWG copper rated to 75 degrees C or better, and it must be protected by a maximum 15 A breaker
Relay contacts	240 VAC, OVC II Pilot duty, B300 (240 V or 120 V, 360 VA)
CT leads	The production CT leads are 1.5m (4.9') long, 18AWG, and are rated for 200A The consumption CT leads are 4m (13.1') long, 18AWG, and are rated for 200A
Typical power draw	3 W
Capacity	
Number of microinverters polled	Up to 600
Mechanical Data	
Dimensions (WxHxD)	21.3 x 12.6 x 4.5 cm (8.4" x 5" x 1.8")
Weight	17.6 oz. (498 g)
Environmental Data	
Ambient temperature range	-40° to 65° C (-40° to 149° F) -40° to 46° C (-40° to 115° F) if installed in an enclosure
Relative Humidity	95%
Environmental rating	IP30. For installation indoors or in an NRTL-certified, NEMA type 3R enclosure
Altitude use	To 2000 meters (6560 feet)
Cooling	Natural convection

Internet Connection Options	
Integrated Wi-Fi	802.11b/g/n (2.4 GHz, 5 GHz)
Ethernet	Optional, 802.3, Cat5E (or Cat 6) UTP Ethernet cable (not included)
Cellular	Optional, CELLMODEM-01 (not included)
Measurement Circuit	
Voltage	120 VAC or 120/240 VAC or 208Y/120 VAC at the power input terminal block
Current	Up to 200 A via CT inputs
Measurement Circuit	Per IEC/EN/CSA/UL 61010, CAT III
Metering options	<ul style="list-style-type: none"> Model ENV-S-AM1-120: Revenue grade production and consumption metering; ANSI C12.20, 0.5 accuracy class. Model ENV-S-AB-120-A: Microinverter reporting; Accuracy +/- 5.0%
CSI Eligibility	The Envoy-S is included in the List of Eligible System Performance Meters for the CSI program.
Compliance	
Compliance	UL 916, CAN/CSA C22.2 No. 61010-1, CAN ICES-003 (B)/NMB-003(B), 47 CFR, Part 15, Class B, IEC/EN 61010-1:2010, EN50065-1, EN61000-4-5, EN61000-6-1, and EN61000-6-2 Metering: ANSI C12.20 accuracy class 0.5 (ENV-S-AM1-120).