

INSTALLATION AND OPERATION MANUAL

Q.PEAK DUO-G10.X+ / AC Solar Module Series

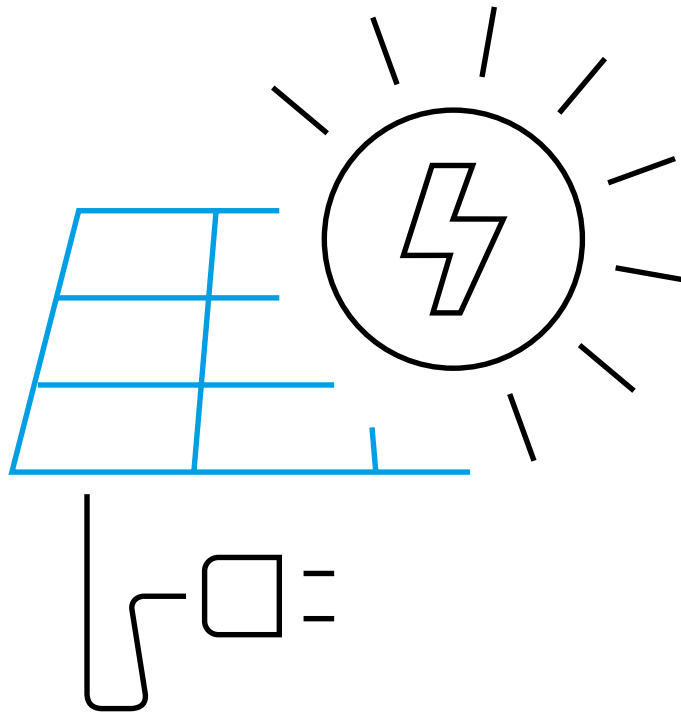

TABLE OF CONTENTS

1	INTRODUCTION	3
2	PLANNING	5
2.1	TECHNICAL SPECIFICATIONS	5
2.2	THE ENPHASE IQ SYSTEM	9
2.3	REQUIREMENTS	10
2.4	MICROINVERTER PLANNING	12
2.5	MOUNTING OPTIONS	14
2.6	ELECTRICAL LAYOUT	16
3	INSTALLATION	17
3.1	SAFETY AND TRANSPORT	17
3.2	PREPARATION OF INSTALLATION	19
3.3	MODULE INSTALLATION	20
4	ELECTRICAL CONNECTION	21
4.1	SAFETY	21
4.2	ELECTRICAL INSTALLATION SAFETY	22
4.3	CONNECTION OF MODULES	23
4.4	AFTER INSTALLATION	24
5	GROUNDING	25
6	FAULTS AND DEFECTS	26
7	DISPOSAL	26
8	MAINTENANCE AND CLEANING	27
9	APPENDIX	28

1 INTRODUCTION

With solar modules from Hanwha Q CELLS America Inc. (hereafter referred to as "Q CELLS") you can directly transform the sun's limitless energy into environmentally-friendly solar electricity. In order to ensure the maximum performance of your Q CELLS solar modules, please read the following instructions completely and carefully and observe all guidelines. Noncompliance may result in damage and / or physical injury.

This installation manual provides instructions for the safe installation and operation of crystalline solar modules.

- ➔ Read these instructions carefully before proceeding with your installation.
- ➔ Retain these instructions for the life of the solar modules.
- ➔ Ensure that this installation manual is available to the operator at all times.
- ➔ This installation manual should be given to all subsequent owners or users of the solar modules.
- ➔ All supplements received from the manufacturer should be included.
- ➔ Observe all other applicable documents.
- ➔ If your questions are not satisfactorily answered in the manual, please contact your system supplier.

Additional information can be found on our website at www.q-cells.us.

Intended Use

This manual is valid in North America for Q CELLS solar modules. These instructions contain information regarding the safe handling and use of quality crystalline solar modules from Q CELLS and their installation, mounting, wiring, maintenance.

Symbols and Labels

The following symbols and labels are used throughout the installation manual for ease of use.

SYMBOL	DESCRIPTION
➔	Procedure with one or more steps
•	Lists of items
☑	Ensure that when carrying out a procedure, you check the results of said procedure.
⊘	Prohibited



Beware of possible danger or damage.
Categories:

- Danger: Risk of fatal injury
- Attention: Risk of serious injury or damage to property
- Note: Risk of damage to product

Units

Where both Imperial and U.S. units (for example inches) are shown, metric units are definitive. References to "Data Sheet" or "Module Data Sheet" refer to the Module Data Sheet applicable to the module being used.

Safety Regulations

The installer and solar module operator are responsible for compliance with all applicable statutory requirements and regulations.

➔ The following regulations and standards must be upheld at all times during the installation, operation, and maintenance of the solar modules:

- Installation and Operation Manual.
- Other applicable documents (such as country-specific regulations for pressure equipment, operational safety, hazardous goods, and environmental protection).
- Regulations and requirements specific to the system.
- Applicable country-specific laws, regulations, and provisions governing the planning, installation, and operation of solar power systems and work on roofs.
- Any valid international, national and regional regulations governing work with direct current, especially those applicable to the installation of electrical devices and systems, and regulations issued by the respective energy provider governing the parallel operation of solar power systems.
- Accident-prevention regulations.

Certified Personnel

Both, the operator and installer are responsible for ensuring that the installation, maintenance, connection to the grid, and dismantling are carried out by trained and qualified electricians and engineers with approved training certificates (issued by a state or Federal organization) for the respective specialist trade. Electrical work may only be performed by an officially certified tradesperson in accordance with the applicable safety standards, accident prevention regulations, and the regulations of the local energy provider. Only qualified personnel should install, troubleshoot, or replace Enphase Microinverters or Enphase Q Cable and Accessories.

1 INTRODUCTION

Validity

These instructions are only valid for crystalline solar modules from the company Q CELLS as specified in chapter "2.1 Technical Specifications". Q CELLS assumes no liability for damage resulting from failure to observe these instructions.

- ➔ Observe the wiring and dimensioning of the system.
 - ➔ The installer of the system is responsible for compliance with all necessary safety regulations during set-up and installation.
- Q CELLS assumes no liability on the basis of these instructions. Q CELLS is only liable in the context of contractual agreements or in the context of accepted guarantees. Q CELLS accepts no other responsibility for the functionality and safety of the modules.
- ➔ Observe the instructions for any other system components that may be part of the complete solar power system. It may be necessary to carry out a structural analysis for the entire project.
 - ➔ If your questions are not satisfactorily answered in the manual, contact your system supplier.

Additional information can be found on our website at www.q-cells.us.

Information for the Operator

- ➔ Keep this installation manual for the entire life of the solar power system.
- ➔ Contact your system supplier for information concerning the formal requirements for solar power systems.
- ➔ Be sure to contact the relevant local authorities and energy providers regarding regulations and permit requirements prior to installation of the solar power system. Your financial success depends on the fulfillment of these requirements.

Other applicable documents

This installation manual is only valid in combination with the following technical information.

DOCUMENT TYPE

- Product data sheet
- Packaging and transport information

MISUSE OR INCORRECT USE OF SOLAR MODULES VOIDS THE LIMITED WARRANTY AND MAY CREATE A SAFETY HAZARD AND RISK PROPERTY DAMAGE. THIS INCLUDES IMPROPER INSTALLATION OR CONFIGURATION, IMPROPER MAINTENANCE, UNINTENDED USE, AND UNAUTHORIZED MODIFICATION.

DO NOT ATTEMPT TO REPAIR THE ENPHASE MICROINVERTER; IT CONTAINS NO USER-SERVICEABLE PARTS. IF IT FAILS, CONTACT ENPHASE CUSTOMER SERVICE TO OBTAIN A RETURN MERCHANDISE AUTHORIZATION (RMA) NUMBER AND START THE REPLACEMENT PROCESS. TAMPERING WITH OR OPENING THE ENPHASE MICROINVERTER WILL VOID THE WARRANTY.

2 PLANNING

2.1 TECHNICAL SPECIFICATIONS

Solar Module

For additional information, see the relevant data sheet of the module provided at www.q-cells.us.

PRODUCT LINE	Q.PEAK DUO-G10+ / AC	Q.PEAK DUO BLK-G10+ / AC
Type	Q.ANTUM DUO Z	Q.ANTUM DUO Z
Length [in]	67.6 (1717 mm)	67.6 (1717 mm)
Width [in]	41.1 (1045 mm)	41.1 (1045 mm)
Frame Height [in]	1.57 (40 mm)	1.57 (40 mm)
Area [yd²]	2.14 (1.79 m ²)	2.14 (1.79 m ²)
Weight [lbs]	46.3 (21.0 kg)	46.3 (21.0 kg)
Max. System Voltage V_{sys}	1000 V	1000 V
Max. Series Fuse Rating	20 A	20 A
Permissible Temperature Range	-40 °F bis +185 °F (-40 °C to +85 °C)	
Junction Box Protection Class	IP67 with bypass diode	
Connector Protection Class	IP68	
Fire Rating Based on ANSI / UL 61730	TYPE 2	TYPE 2
Max. Test Load Push / Pull¹ [lbs/ft²]	125 / 113 (6,000 Pa / 5,400 Pa)	125 / 113 (6,000 Pa / 5,400 Pa)
Max. Design Load Push / Pull¹ [lbs/ft²]	83 / 75 (4,000 Pa / 3,600 Pa)	83 / 75 (4,000 Pa / 3,600 Pa)
Certificates	CE-compliant; IEC 61215:2016; IEC 61730:2016; PV module classification: Class II; UL 61730, UL 1741 SA	

¹ Test and design load in accordance with IEC 61215:2016, depending on mounting options (see section "2.5 Mounting Options")

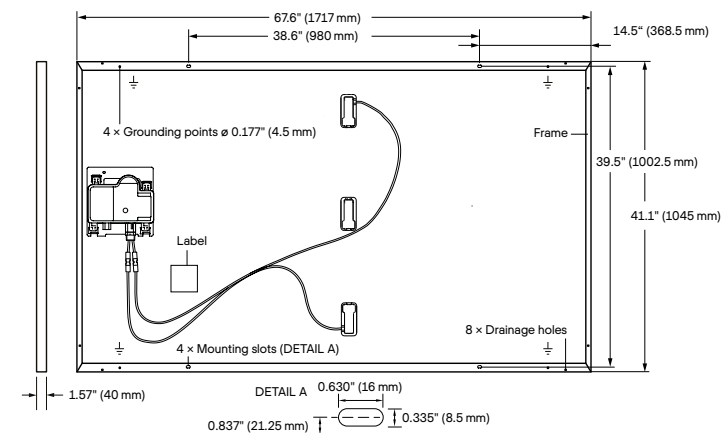

Fig. 1: External dimensions in inch (mm) and components for Q.PEAK DUO-G10+ / AC and Q.PEAK DUO BLK-G10+ / AC

2 PLANNING

2.1 TECHNICAL SPECIFICATIONS

Microinverter

For additional information see the relevant datasheet of the microinverter provided at www.enphase.com.

ENPHASE IQ7PLUS-72-X-ACM-US MICROINVERTER PARAMETERS

Topic	Unit	Min	Typical	Max
DC PARAMETERS				
Peak Power Tracking Voltage	V	27	36	45
Operating Voltage Range	V	16		60
Maximum Input DC Voltage	V			60
Minimum / Maximum Start Voltage	V	22		60
Maximum DC Input Short Circuit Current (module Isc)	A			15
Overvoltage Class DC Port			II	
DC Port Backfeed under Single Fault	A			0
PV Array Configuration	1x1 ungrounded array; No additional DC side protection required; AC side protection requires max 20A per branch circuit			
AC PARAMETERS				
Maximum Continuous AC Output Power (-40°C to +65°C)	VA		290	
Peak Output Power	VA		295	
Power Factor (adjustable)			0.85 leading	
Nominal AC Output Voltage Range ¹ 240 VAC (single phase) 208 VAC (single phase)	Vrms	211		264
	Vrms	183		229
Maximum Continuous Output Current 240 VAC (single phase) 208 VAC (single phase)	A		1.21	
	A		1.39	
Nominal Frequency	Hz		60	
Extended Frequency Range	Hz	47		68
Maximum AC Output over Current Protection Device	A		20	
Maximum AC Output Fault Current & Duration	Arms over 3 cycles		5.8	
High AC Voltage Trip Limit Accuracy	%	±1.0		
Low AC Voltage Trip Limit Accuracy	%	±1.0		
Frequency Trip Limit Accuracy	%	±0.1		
Trip Time Accuracy	milliseconds		±0.1% or 2 cycles	
Overvoltage Class AC Port			III	
AC Port Backfeed under Single Fault	A		0	
Power Factor Setting			1.0	

¹ Nominal Voltage Range can be extended if required by the utility.

2 PLANNING

2.1 TECHNICAL SPECIFICATIONS

Topic	Unit	Min	Typical	Max
MISCELLANEOUS PARAMETERS				
Maximum Microinverters per 20 amp Branch Circuit 240 VAC (single phase) 208 VAC (single phase)	A			13
				11
CEC Weighted Efficiency 240 VAC (single phase) 208 VAC (single phase)	%	97.0		
		96.5		
Static MPPT Efficiency (weighted, ref EN 50530)	%	99.0		
Total Harmonic Distortion	%			5
Ambient Temperature Range	°C	-40		+65
Night Tare Loss	mW			50
Storage Temperature Range	°C	-40		+85
FEATURES AND SPECIFICATIONS				
Dimensions Excluding Mounting Bracket (approximate)	8.35 in × 6.89 in × 1.19 in (212mm × 175mm × 30.2mm)			
Connector Type	Stäubli MC4, EN4 BULKHEAD			
Weight	2.38 lbs. (1.08 kg)			
Environmental Category / UV Exposure Rating	NEMA Type 6 / Outdoor			
Cooling	Natural convection - no fans			
Relative Humidity Range	4% to 100% condensing			
Approved for Wet Locations	Yes			
Pollution Degree	PD3			
Maximum Altitude	6561 feet (2000 meters)			
Compliance	CA Rule 21 (UL 1741-SA) UL 62109-1, UL1741 / IEC62109-1, FCC Part 15 Class B, ICES-0003 Class B, CAN / CSA-C22.2 NO. 107.1-01; This product is UL Listed as PV Rapid Shutdown Equipment and conforms with NEC-2014 and NEC-2017 Section 690.12 and C22.1- 2015 Rule 64-218 Rapid Shutdown of PV Systems, for AC and DC conductors, when installed according to manufacturer's instructions.			
Grounding	The DC circuit meets the requirements for ungrounded PV arrays in NEC. Ground fault protection (GFP) is integrated into the class II double insulated microinverter.			
Monitoring	Enlighten Manager and MyEnlighten monitoring options require an Enphase IQ Envoy			
Communication	Power line			
Integrated DC Disconnect	The DC connector has been evaluated and approved for use as the load-break disconnect required by NEC 690.			
Integrated AC Disconnect	The AC connector has been evaluated and approved for use as the load-break disconnect required by NEC 690.			

2 PLANNING

2.1 TECHNICAL SPECIFICATIONS

Enphase Q Cable

For additional information, see the relevant datasheet of the module provided at www.q-cells.us.

SPECIFICATION	VALUE
Voltage Rating	600V
Voltage Withstand Test (kV / 1 min)	AC 3.0
Max DC Conductor Resistance (68 °F / 20 °C) (Ω / km)	5.433
Insulation Resistance (68 °F / 20 °C)	$\geq 20M$ (Ω / km)
System Temperature Range (ambient)	-40 °F to 149 °F (-40°C to +65°C)
Cable temperature rating	194 °F (90 °C) Dry / 194 °F (90 °C) Wet
Cable rating	DG
Certification	UL 3003, TC-ER equivalent
Flame test rating	FT4
Cable conductor insulator rating	THHN / THWN-2
Environmental protection rating	IEC 60529 IP67 NEMA 6
UV resistance	720h
Compliance	RoHS, OIL RES I, CE, UV Resistant, combined UL for Canada and United States
Conductor size	12 AWG
Maximum loop size	4.75 in (12 cm)
Drop connector dimensions	4.64 in \times 2.36 in \times 1.25 in (11.8 cm \times 6.0 cm \times 3.2 cm)
Terminator cap dimensions	1.4 in diameter \times 2 in tall (3.6 cm \times 5.1 cm)

Enphase Connector Ratings

Enphase connectors in the following table have a maximum current of 20 A, a maximum OCPD of 20 A, and an ambient temperature range of -40 °F to +174.2 °F (-40 °C to +79 °C).

PART NUMBER	MODEL	MAXIMUM VOLTAGE
840-00387	Q-12-10-240	277 VAC
840-00388	Q-12-17-240	277 VAC
840-00389	Q-12-20-200	277 VAC



NOTE!

Only Enphase connectors/solar cables are permitted.

2 PLANNING

2.2 THE ENPHASE IQ SYSTEM

The Enphase IQ System includes:

The smart grid ready microinverter converts the DC output of the PV module into grid-compliant AC power.

- **Enphase IQ Envoy™** (model ENV-IQ-AM1-240) communications gateway or IQ Combiner (model X-IQ-AM1-240-2 or 240-3): The Enphase IQ Envoy is a communication device that provides network access to the PV array. The IQ Envoy collects production and performance data from the Enphase IQ Microinverters over on-site AC power lines and transmits the data to Enlighten through an internet or cellular modem connection. The IQ Envoy is capable of monitoring up to 600 Enphase IQ Microinverters and up to 39 Enphase IQ Batteries. For details, refer to Enphase's IQ Envoy Installation and Operations Manual.
- **Enphase Enlighten™** web-based monitoring and management software. Installers can use Enlighten Manager to view detailed performance data, manage multiple PV systems, and remotely resolve issues that might impact system performance. Find out more at enphase.com/enlighten.
- **Enphase Installer Toolkit™** mobile app for iOS and Android devices. It allows installers to configure the system while onsite, eliminating the need for a laptop and improving installation efficiency. You can use the app to:
 - Connect to the IQ Envoy over a wireless network for faster system setup and verification
 - View and email a summary report that confirms a successful installation
 - Scan device serial numbers and sync system information with Enlighten monitoring software
- **Enphase Field Wireable Connectors** (Q-CONN-10F and Q-CONN-10M)
 - Use Enphase Field Wireable Connectors with Enphase Q Cable or field cable to:
 - Easily connect Q Cable on the roof without complex wiring
 - Use female connectors to make connections from any Q Cable open connector
 - Make a jumper to connect with a remote part of the array: Use female to female for cable-to-cable connections
 - Use a mated pair of connectors to splice two cut ends of cable

How the AC Module Works

The Enphase Microinverter maximizes energy production by using a sophisticated Maximum Power Point Tracking (MPPT) algorithm. Each Enphase Microinverter is individually connected to one PV module on the array. This configuration enables an individual MPPT to control each PV module, ensuring that maximum power available from each PV module is exported to the utility grid regardless of the performance of the other PV modules in the array.

While an individual PV module in the array may be affected by shading, soiling, orientation, or PV module mismatch, each Enphase Microinverter ensures top performance for its associated PV module.

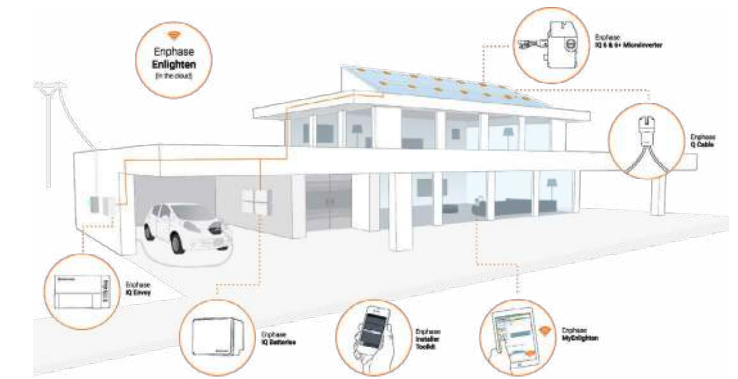

System Monitoring

Once you install the Enphase IQ Envoy or Enphase IQ Combiner and provide an internet connection through a broadband router or modem, the Enphase IQ Microinverters automatically begin reporting to Enlighten. Enlighten presents current and historical system performance trends and informs you of PV system status.

Optimal Reliability

Microinverter systems are inherently more reliable than traditional inverters. The distributed nature of a microinverter system ensures that there is no single point of system failure in the PV system. Enphase Microinverters are designed to operate at full power at ambient temperatures as high as 150 °F (65 °C).

Ease of Design

PV systems using Enphase Microinverters are very simple to design and install. You will not need string calculations or cumbersome traditional inverters. Low voltage DC wires connect from the PV module directly to the co-located microinverter, eliminating the risk of personnel exposure to dangerously high DC voltage.

2 PLANNING

2.3 REQUIREMENTS

Installation Site

Note the following guidelines that apply to the installation site:

- Solar modules are not explosion-proof and are not suitable for use in explosive environments.
- ➔ Do not operate solar modules near highly flammable gas and vapors (e.g., gas tanks, gas stations).
- ➔ Do not install modules in enclosed spaces.
- ➔ Do not install modules in locations where they may be submerged in water (e.g., floodplains).
- ➔ Do not use modules as a substitute for the normal roofing (e.g., modules are not watertight).
- ➔ Do not install modules in close proximity to air conditioning systems.
- ➔ Do not install modules above 6,561 ft (2,000 m) altitude above sea level.
- ➔ Contact with saline water (e.g., spray water from the sea) and salt aggregation on the modules must be avoided.
- ➔ Do not bring any chemical substance (e.g., oil, solvent etc.) into contact with any part of the panel. Only substances approved by Q CELLS should be used during installation, operation, and maintenance.
- ➔ Any installation of modules on surfaces of water is prohibited. This includes installations on floating as well as pile-based platforms. Q CELLS may extend the coverage of its warranty to such installations, based on a case assessment of the system design and location. A prior written consent by the warrantor is required in any case.

Prevention of Shadowing Effects

Optimal solar irradiation leads to maximum energy output:

- ➔ For this reason, install the modules so that they face the sun.
- ➔ Avoid shadowing (due to objects such as buildings, chimneys or trees).
- ➔ Avoid partial shading (for example through overhead lines, dirt, snow).

Limitations

The solar modules are designed for the following applications:

- Operating temperatures from -40°F to $+185^{\circ}\text{F}$.
- Pull loads and push loads according to chapter 2.3 ('Test Load' in accordance with IEC 61215 and 'Design Load $\times 1.5$ ' in accordance with UL 61730).
- Installation using a mounting structure for solar modules.

Mounting Structure Requirements

Requirements for the mounting structure:

- Conforms to the necessary structural requirements.
- Compliant with local snow and wind loads.
- Properly fastened to the ground, the roof, or the façade.
- Forces acting on the module are relayed to the mounting sub-structure.
- Ensures sufficient rear ventilation of the module.
- Avoids the usage of different metals to prevent contact corrosion.
- Allows for stress-free expansion and contraction due to temperature fluctuations.
- ➔ Ensure that no additional forces are applied through the mounting system into the module except for the wind and snow loads. Additional forces and moments of torque at the mounting positions caused by torsions, displacements or vibrations in the mounting system are not allowed.
- ➔ Ensure that the clamps and the mounting frame are compatible.

Clamp System Recommendations

Use customary clamps that satisfy the following requirements:

- Clamp width: ≥ 1.5 in (38 mm).
- Clamp height compliant with a 1.57 in (40 mm) frame height.
- Clamp depth: 0.28-0.47 in (7-12 mm) (applicable for all CL clamping mounting options at section "2.5 Mounting Options").
- Clamps are not in contact with the front glass.
- Clamps do not deform the frame.
- Clamps that satisfy the structural requirements based on the conditions of the installation site according to the applicable regulations and technical standards.
- Long-term stable clamps that securely affix the module to the mounting frame.

Module Orientation Requirements

- Vertical or horizontal installation is permitted.
- ➔ Ensure that rain and melting snow can run off freely. No water accumulation.
- ➔ Ensure that the drainage holes in the frame are not covered. No sealing.

2 PLANNING

2.3 REQUIREMENTS

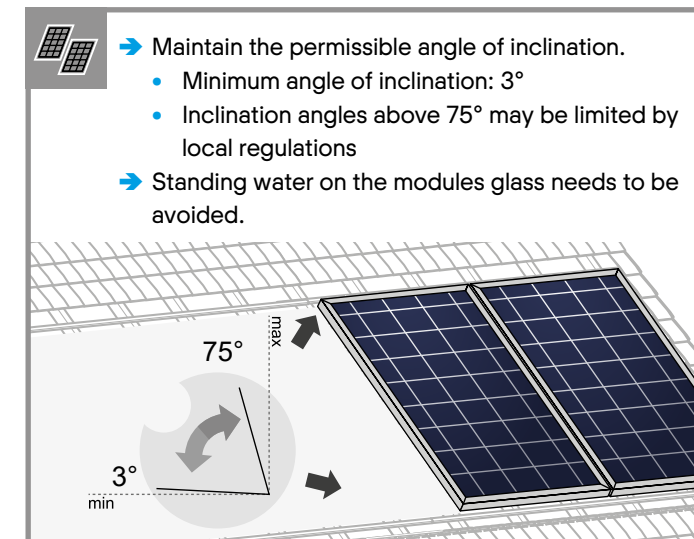

2 PLANNING

2.4 MICROINVERTER PLANNING

Installation Site

The microinverter housing is designed for outdoor installation and complies with the NEMA 250, type 6 environmental enclosure rating standard:

NOTE!
NEMA 6 Rating Definition:

Indoor or outdoor use primarily to provide a degree of protection against hose-directed water, the entry of water during occasional temporary submersion at a limited depth, and damage from external ice formation

The Enphase Q Cable is available with connector spacing options to accommodate installation of PV modules in portrait or landscape orientation. For Enphase Q Cable ordering information, see “Enphase Q Cable Planning and Ordering” on page 30.

Planning the Racking

Plan the racking position with the microinverter in mind. Ensure that the racking does NOT interfere with the microinverter and its connectors.

Grounding Considerations

The Enphase Microinverter models listed in this guide do not require grounding electrode conductors (GEC), equipment grounding conductors (EGC), or grounded conductors (neutral). Your Authority Having Jurisdiction (AHJ) may require you to bond the mounting bracket to the racking. If so, use UL2703 hardware or star washers. The microinverter itself has a Class II double-insulated rating, which includes ground fault protection (GFP).

Branch Circuit Capacity

Plan your AC branch circuits to meet the following limits for maximum number of microinverters per branch when protected with a 20 amp (maximum) over current protection device (OCPD).

**MAXIMUM* IQ 7+ MICROS
PER AC BRANCH CIRCUIT (240 VAC)**

13

**MAXIMUM* IQ 7+ MICROS
PER AC BRANCH CIRCUIT (208 VAC)**

11

NOTE!

*Limits may vary. Refer to local requirements to define the number of microinverters per branch in your area.

Utility Service Requirements

The Enphase IQ Microinverter for ACM work with a single-phase service. Measure AC line voltages at the electrical utility connection to confirm that it is within the ranges shown:

240 VOLT AC, SINGLE PHASE	
L1 to L2	211 to 264 VAC
L1, L2 to ground	106 to 132 VAC
208 VOLT AC, SINGLE PHASE	
L1 to L2	183 to 229 VAC
L1, L2 to ground	106 to 132 VAC

Wire Lengths and Voltage Rise

When planning the system, you must select the appropriate AC conductor size to minimize voltage rise. Select the correct wire size based on the distance from the beginning of the AC branch circuit to the breaker in the load center. Enphase recommends a voltage rise total of less than 2% for the sections from the AC branch circuit to the breaker in the load center.

Enphase provides guidance about choosing wire size and maximum conductor lengths in the Voltage Rise Technical Brief at enphase.com/support. Refer to this brief for voltage rise values in Enphase Q Cables and on how to calculate voltage rise in other wire sections of the system.

Standard guidelines for voltage rise on feeder and AC branch circuit conductors might not be sufficient for microinverter AC branch circuits that contain the maximum allowable microinverters. This is due to high inherent voltage rise on the AC branch circuit.

NOTE!
Best practice:

Center-feed the branch circuit to minimize voltage rise in a fully-populated branch. This practice greatly reduces the voltage rise as compared with an end-fed branch. To center-feed a branch, divide the circuit into two sub-branch circuits protected by a single OCPD.

2 PLANNING

2.4 FOR MICROINVERTER PLANNING

Lightning and Surge Suppression

Enphase Microinverters have integral surge protection greater than most traditional inverters. However, if the surge has sufficient energy, the protection built into the microinverter can be exceeded, and the equipment can be damaged. For this reason, Enphase recommends that you protect your system with a lightning and / or surge suppression device. In addition to having some level of surge suppression, it is also important to have insurance that protects against lightning and electrical surges. Enphase has tested the following devices:

- Leviton 51110-SRG
- Schneider SquareD HEPD50

NOTE!

Protection against lightning and resulting voltage surge must be in accordance with local standards.

Parts and Tools Required

In addition to the AC Modules, you will need the following:

Enphase Equipment

- **Enphase IQ Envoy** (model ENV-IQ-AM1-240) communications gateway or **IQ Combiner** (model X-IQ-AM1-240-2 or 240-3): required to monitor solar production. For installation information, refer to the Enphase IQ Envoy Installation and Operations Manual.
- **Enphase Installer Toolkit:** Download the Enphase Installer Toolkit mobile app and open it to log in to your Enlighten account. With this app, you can scan microinverter serial numbers and connect to the IQ Envoy to track system installation progress. To download, go to enphase.com/toolkit.
- Tie Wraps or Cable Clips (Q-CLIP-100)
- Enphase Sealing Caps (Q-SEAL-10) for any unused drops on the Enphase Q Cable
- Enphase Terminator (Q-TERM-10) typically two needed per branch circuit
- Enphase Disconnect Tool (Q-DISC-10)
- Field Wireable Connectors (male and female: Q-CONN-10M and Q-CONN-10F) (optional)
- Enphase Q Cable:

CABLE MODEL	CONNECTOR SPACING	PV MODULE ORIENTATION	CONNECTOR COUNT PER BOX
Q-12-10-240	1.3m	Portrait	240
Q-12-17-240	2.0m	Landscape (120-cell)	240

NOTE!

Only Enphase connectors / solar cables are permitted.

Other Items

- Racking, AC junction box, homerun
- Tools:
 - screwdrivers
 - wire cutter
 - voltmeter
 - torque wrench
 - sockets and wrenches for mounting hardware
- Crimp tool PV-CZM-18100, -019100, or -22100 for field wireable connectors (optional)
- Compatible cable clips

2 PLANNING

2.5 MOUNTING OPTIONS

Fig. 2: Installation options for crystalline Q CELLS modules. All dimensions are given in inches (mm in brackets). Also observe the maximum test loads and clamping range as specified on the following page.

The illustrated installation options apply for both horizontal and vertical module orientation.

 Module
  Clamp
  Subconstruction
  Mounting profile

TYPE OF INSTALLATION	POINT MOUNTING SYSTEM	LINEAR MOUNTING SYSTEM
INSTALLATION WITH CLAMPS		
HYBRID CLAMPING		
INSTALLATION ON MOUNTING POINTS		

2 PLANNING

2.5 MOUNTING OPTIONS

TYPE OF INSTALLATION	POINT MOUNTING SYSTEM	LINEAR MOUNTING SYSTEM
INSTALLATION WITH INSERTION PROFILES	NOT PERMITTED	

Specifications

MOUNTING OPTION	POSITION OF CLAMPS* [IN (MM)]	TEST LOAD PUSH / PULL** [PA]	DESIGN LOAD PUSH / PULL** [PA]	SAFETY FACTOR
CL1a (Max. span: 49.2 in)	5.12 - 13.8 (130 - 350)	6000 / 5400	4000 / 3600	1.5
	0.79 - 17.7 (20 - 450)	5400 / 3600	3600 / 2400	
	7.87 - 23.2 (20 - 590)	4000 / 2800	2660 / 1865	
CL1a	0.79 - 25.6 (20 - 650)	2400 / 2400	1600 / 1600	
CL1b	11.8 - 19.7 (300 - 500)	2400 / 2400	1600 / 1600	
CL2a (with rails)	0.79 - 3.94 (20 - 100)***	3600 / 2400	2400 / 1600	
CL2b (without rails)	0.79 - 7.87 (20 - 200)	2400 / 2400	1600 / 1600	
CL3	9.45 - 13.8 (240 - 350)	4000 / 4000	2660 / 2660	
CL5	short side: 0.79 - 3.94 (20 - 100) long side: 11.8 - 17.7 (300 - 450)	3600 / 3300	2400 / 2200	
CL6a	outer clamps: 0.79 - 15.7 (20 - 400) middle clamps: 22.0 - 45.7 (560 - 1160) ***	8100 / 4000	5400 / 2660	
CL6c	outer clamps: 0.79 - 15.7 (20 - 400) middle clamps: 22.0 - 45.7 (560 - 1160) ***	3600 / 3600	2400 / 2400	
CL6d	Outer clamps: 0.79 - 9.84 (20 - 250) middle clamps: 22.0 - 45.7 (560 - 1160) ***	4000 / 3600	2660 / 2400	
FB1	14.5 (368.5)	5400 / 4000	3600 / 2660	
FB2	14.5 (368.5)	4000 / 4000	2660 / 2660	
IP1	-	3600 / 3300	2400 / 2200	

* Distance between outer edge of module and middle of the clamp; consider further details below.
 ** Loads according to IEC 61215-2:2016 and UL 61730.
 *** Rails must not be under the junction box.

2 PLANNING

2.5 MOUNTING OPTIONS

MOUJNTING OPTIONS	REQUIREMENTS
All	<ul style="list-style-type: none"> → The loads in the table are related to the mechanical stability of the solar modules. The mechanical stability of the mounting system including clamps has to be evaluated by the system supplier. The listed test load values have been determined with the following clamp parameters: clamp width = 1.57 in (40 mm) and clamp depth = 0.39 in (10 mm). → The system installer is responsible for the determination of location-specific load requirements. → Ensure that the connection cables of the junction box and microinverter do not run between laminate and mounting rails. → If connection cable runs between laminate and mounting it should be running at mounting rails position close to frame parts. → Modules bend under load. Therefore, sharp objects (e.g. screws, ballast stones, rail ends, rails with burrs or sharp corners) must not be placed near the module backside so as not to touch the laminate under load. → Mounting rails must not be mounted under the junction box and microinverter. → Ensure that the junction boxes do not touch the mounting structure (e.g. shorts rails, ballast, etc.) or the rooftop under load. Clamps or insertion profiles etc. must not touch the glass (even under load). → Unbalanced loads (e.g. snow overhangs, snowdrifts) which result in locally significantly increased loads must be removed or avoided by technical measures.
CL1a, CL2a, CL3, CL6a, FB1, FB2	<ul style="list-style-type: none"> → Ensure that module frame is fixed directly on the rail of the substructure (no spacer allowed between the module and substructure).
CL1a	<ul style="list-style-type: none"> → At push test loads of 4000, 5400, 6000 Pa: The clamp position is variable in the given range but the distance between the clamps along the long side of the module (span) must not be larger than 49.2 in (1250 mm).
CL1b	<ul style="list-style-type: none"> → Using of short mounting rails are permissible, if they overlap with the module less than 8.27 in (210 mm). Maintain a minimum distance (clearance) of ≥ 2.17 in (55 mm) between frame bottom edge and roof top or ballast
CL1b, CL2b, CL3, CL6c, CL6d, FB2	<ul style="list-style-type: none"> → A minimum support depth of 0.59 in (15 mm) is required on the back side of the module.
CL3, CL6c, CL6d, IP1, FB2	<ul style="list-style-type: none"> → Maintain a minimum distance (clearance) of ≥ 2.36 in (60 mm) between frame bottom edge and roof top or ballast
CL5	<ul style="list-style-type: none"> → Maintain a minimum distance (clearance) of ≥ 2.76 in (70 mm) between frame bottom edge and roof top or ballast. → The minimum required support depth on the module backside is 0.39 in (10 mm) on long frame side and 0.59 in (15 mm) on short frame side.
CL6c, CL6d	<ul style="list-style-type: none"> → Use of short mounting rails under the modules are permissible, if they do not touch the laminate under load.
IP1	<ul style="list-style-type: none"> → Ensure minimum support depth of 0.59 in (15 mm) on the backside and 0.39 in (10 mm) on the front side of the module.
FB1, FB2	<ul style="list-style-type: none"> → Use M8 corrosion-proof screws and washers (diameter ≥ 0.62 in (15.8 mm)) for mounting slots (Detail A, Fig.1). Mounting screws and washers should have the same material properties.

2 PLANNING

2.6 ELECTRICAL LAYOUT

Module Selection

For detailed key electrical data, refer to the product data sheet for the respective product (available at www.q-cells.us).

Safety Factor

During normal operation, a module may generate a greater current and / or higher voltage than that determined under standardized test conditions. Accordingly, the values of I_{sc} and V_{oc} marked on the module should be multiplied by a factor of 1.25 when determining:

- the component voltage ratings
- conductor ampacities
- fuse sizes
- size of controls connected to the PV output

Refer to Section 690-8 of the National Electrical Code for an additional multiplying factor of 125 percent (80 percent derating) which might be applicable.

- Follow the valid national guidelines for the installation of electrical systems (refer to section 690-8 of the NEC for an additional multiplying factor of 125 percent [80 percent derating] which may be applicable).

Module Connection

Detailed information about interconnecting modules are specified in section "9 Appendix" on page 29.



NOTE!

When installing different product versions, the lowest minimum permitted reverse current load capacity applies.

3 INSTALLATION

3.1 SAFETY AND TRANSPORT

! → Ensure that all personnel are aware of and adhere to accident-prevention and safety regulations.
→ While working wear clean gloves.

! **DANGER! Risk of fatal injury due to electric shock!**
→ Do not install damaged modules.
→ Inform your vendor of any damages immediately.

! → Inspect the packaging for damages.
→ Contact the transport company regarding any damage to the packaging and follow their instructions.
→ Follow any instructions on the packaging.

! **WARNING! Fire Risk!**
→ Do not install modules indoors.
→ Do not install modules on moving objects.
→ Do not use Enphase equipment in a manner not specified by the manufacturer. Doing so may cause death or injury to persons, or damage to equipment.

! → Leave modules in their original packaging until installation.
→ Store the modules securely in cool and dry rooms. The packaging is not weatherproof.

3 INSTALLATION

3.1 SAFETY AND TRANSPORT

! **NOTE! Module damage may occur!**
→ Never lift or move the module with the connection cables or junction box.
→ Carry modules upright and horizontally as shown.

! **NOTE! Module damage may occur!**
→ Never step on modules.
→ Do not subject modules to any mechanical stress.
→ Do not allow any objects to fall onto modules.

! **NOTE! Module damage may occur!**
→ Do not drop modules.

! **NOTE! Module damage may occur!**
→ Only make modifications to the module which have been confirmed in writing by Q CELLS.

Q CELLS
confirmation letter

! **NOTE! Module damage may occur!**
→ Do not stack modules.

! **NOTE! Module damage may occur!**
→ Do not install modules near flammable gas / vapors.
→ Do not install modules in close proximity to air conditioning systems.

3 INSTALLATION

3.2 PREPARATION OF INSTALLATION

! DANGER! Risk of fatal injury due to electric shock!

- Block off the installation zone.
- Keep children and unauthorized individuals away from the solar power system.

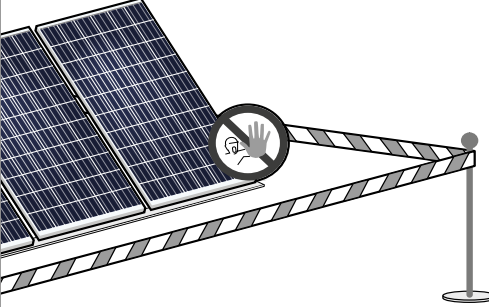

! WARNING! Risk of injury due to falling modules!

- Secure modules during installation.
- Do not install modules in windy or wet weather.

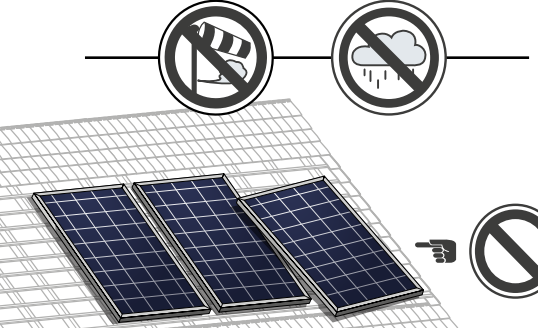

! DANGER! Risk of fatal injury due to electric shock!

- Only use dry, insulated tools.

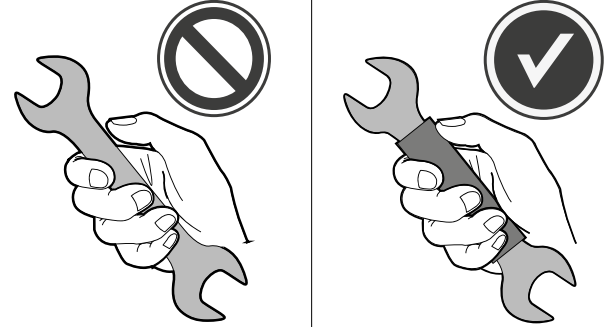

! Do not carry out the installation alone.

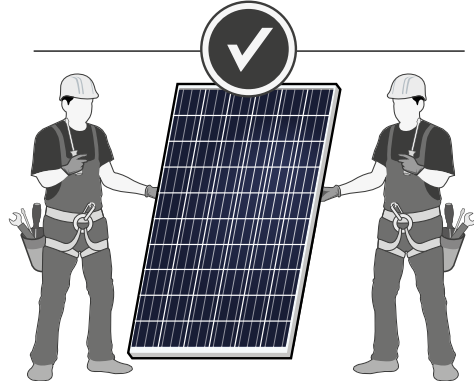

! DANGER! Risk of fatal injury due to electric shock!

- Ensure that modules and tools are not subject to moisture or rain at any time during installation.
- Only use electrical system components approved for wet locations.

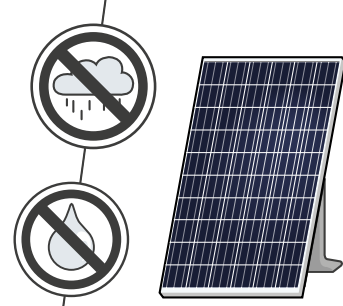

! Only install undamaged modules and components.

- Do not modify the module (e.g., do not drill any additional holes).

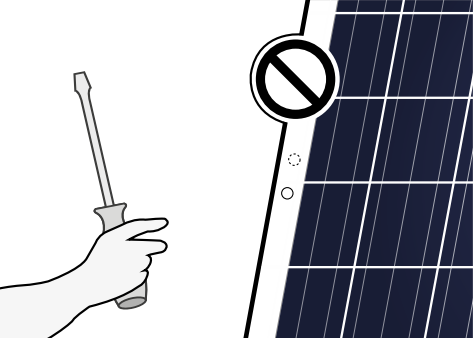

3 INSTALLATION

3.3 MODULE INSTALLATION

Option 1:

- Fasten the module with 4 clamps in the specified clamping range, see Fig. 2, p. 14.
- Tighten clamps according to manufacturer's instructions.

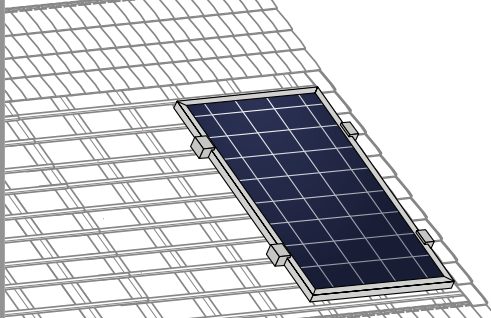

→ Maintain an interval of at least 0.39 in (10 mm) between two modules along the short side and 0.20 in (5 mm) along the long side.

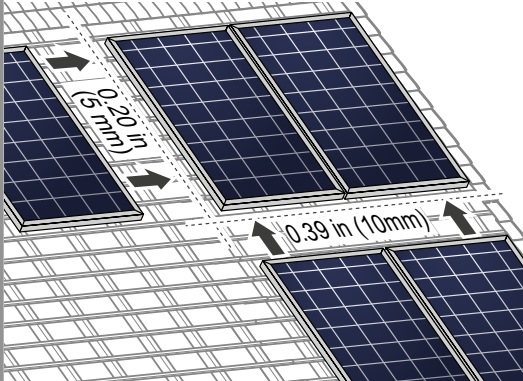

Option 2:

- Install the module at the 4 mounting points, see Fig. 2, p. 14.
- Tighten screws according to manufacturer's instructions.

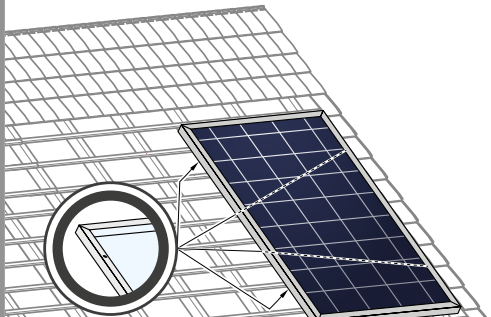

! NOTE! Module damage may occur!

- Do not subject modules to mechanical tension. Max. torsion 0.12 in / ft (10 mm/m).

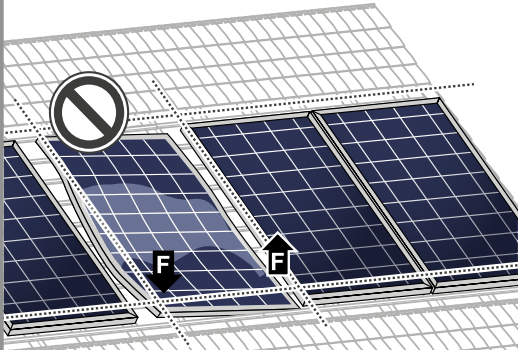

Option 3:

- Install the module using mounting profiles, see Fig. 2, p. 14.

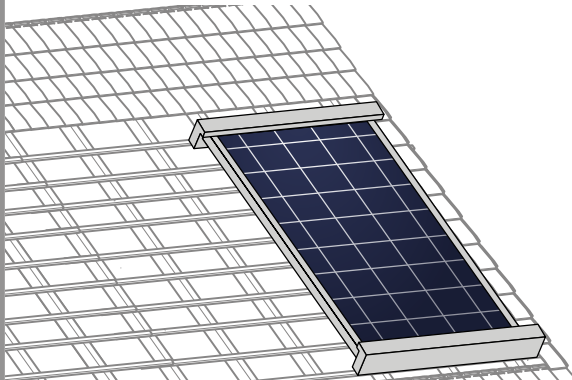

! NOTE! The Enphase Microinverter Installation Manual can be found in the appendix.

Installing the Enphase IQ Microinverter involves several key steps. Each step is listed in detail, please see pages 28-48.

4 ELECTRICAL CONNECTION

4.1 SAFETY



DANGER! Risk of fatal injury due to electric shock!

When disconnecting an electric circuit carrying direct current, electric arcs can occur that may result in life-threatening injuries.

- Do NOT unplug the cable when under load.
 - Do NOT connect any exposed cable ends.
-
- Electrical work may only be performed by qualified and skilled personnel (see page 3).

A solar module generates electrical current and voltage even at a low intensity of illumination. Sparks and electric arcs may result from the separation of a closed circuit. These can result in life-threatening injuries. The danger increases when several modules are connected in series.

- Be aware that the entire open circuit voltage is active even at low levels of solar irradiation.
- Follow the valid national regulations and safety guidelines for the installation of electrical devices and systems.
- Make sure to take all necessary safety precautions. With module or phase voltages of more than 120 V, the safety extra-low voltage range is exceeded.
- Carry out work on the inverter and the wiring with extreme caution.
- Ensure that the modules are disconnected at the inverter prior to separation.
- Be sure to observe the time intervals specified by Enphase.
- Make sure that the plugs cannot be connected unintentionally.
- Before working on the contacts, check them for safety extra-low voltage.
- Do not exceed the maximum number of microinverters in an AC branch circuit as listed in the manual. You must protect each microinverter AC branch circuit with a 20A maximum breaker or fuse as appropriate.
- Do not connect Enphase Microinverters to the grid or energize the AC circuit(s) until you have completed all of the installation procedures and have received approval from the electrical utility company.
- When the PV array is exposed to light, DC voltage is supplied to the power conversion equipment (PCE).
- The AC and DC connectors on the cabling are rated as a disconnect only when used with an Enphase Microinverter.
- The Enphase Microinverter is not protected from damage due to moisture trapped in cabling systems. Never mate microinverters to cables that have been left disconnected and exposed to wet conditions. This will void Enphase's warranty.



DANGER! Risk of fatal injury due to electric shock!

- Only use dry, insulated tools for electrical work.

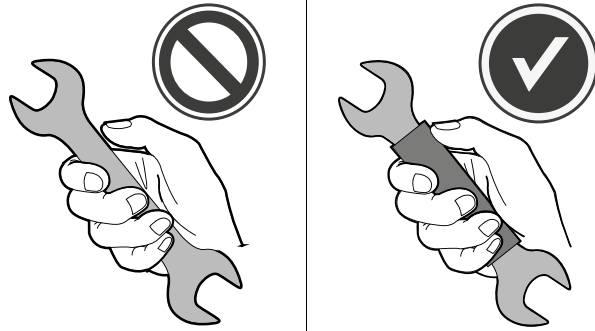

DANGER! Risk of fatal injury due to electric shock!

- Never open the junction box.
- Do not remove bypass diodes.

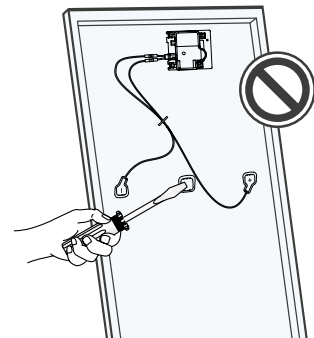

DANGER! Risk of fatal injury due to electric shock!

- Never touch live contacts with bare hands.
- Cover connectors by suitable protective caps until installation.
- The DC conductors of this photovoltaic system are ungrounded and may be energized.

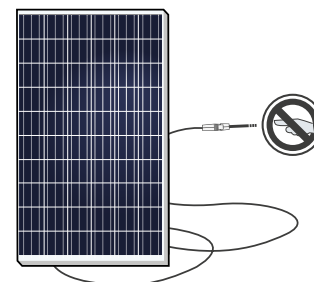

4 ELECTRICAL CONNECTION

4.2 ELECTRICAL INSTALLATION SAFETY



WARNING! Fire Risk!

- The body of the Enphase Microinverter is a heat sink. Under normal operating conditions, the temperature could be 20 °C above ambient, but under extreme conditions the microinverter can reach a temperature of 90 °C. To reduce risk of burns, use caution when working with microinverters.

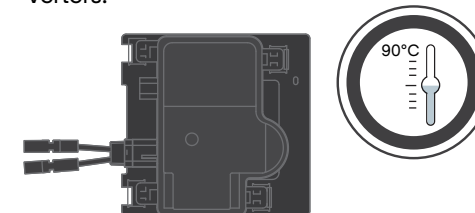

DANGER! Risk of fatal injury due to electric shock!

- Use the terminator to seal the conductor end of the Enphase Q Cable; no other method is allowed.
- Only connect cables with plugs.

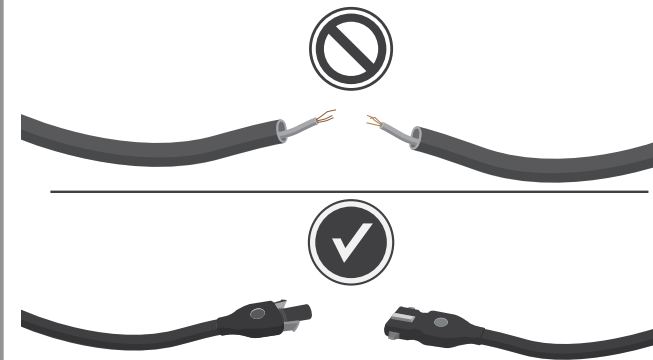

DANGER! Risk of fatal injury due to electric shock!

- Be sure to maintain the time intervals as specified by the inverter manufacturer between switching off the inverter and beginning any further work.

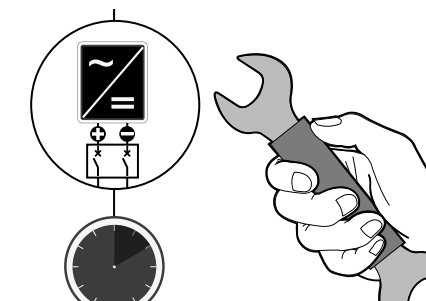

DANGER! Risk of fatal injury due to electric shock!

- Never plug or unplug the cable when under load. Modules must not carry any current.
- Switch off the Enphase microinverter, please see section "9 Appendix" on page 29.

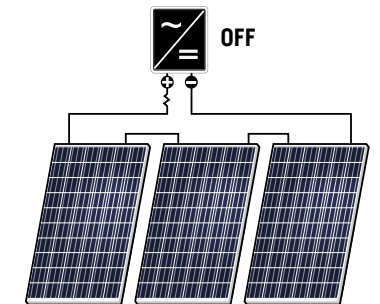

4 ELECTRICAL CONNECTION

4.3 CONNECTION OF MODULES

! → Only use connector and solar cables provided from Enphase (Q Cable, please see page 8).

→ Only interconnect connectors of the same type and manufacturer.

→ Use minimum No. 12 AWG copper wires insulated for a minimum of 194 °F (90 °C) for field connections.

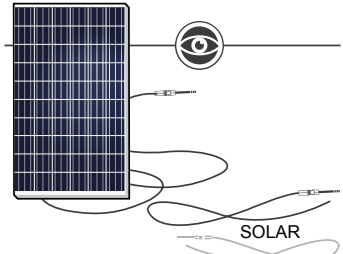

! **NOTE! Module damage may occur!**

→ Ensure that the cabling is not under mechanical stress (Comply with bending radius of ≥ 2.36 in (60 mm)).

→ Ensure that the cables do not run between module and mounting rail or structure (danger of pinch).

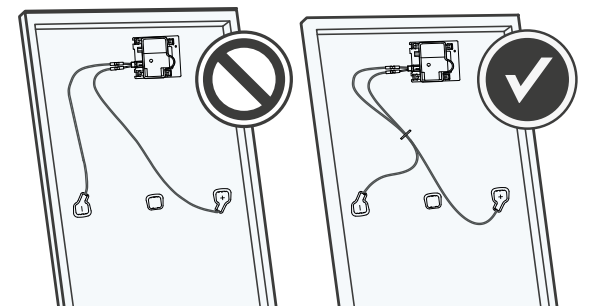

! **DANGER! Risk of fatal injury due to electric shock!**

→ Ensure that all electrical components are in a proper, dry, and safe condition.

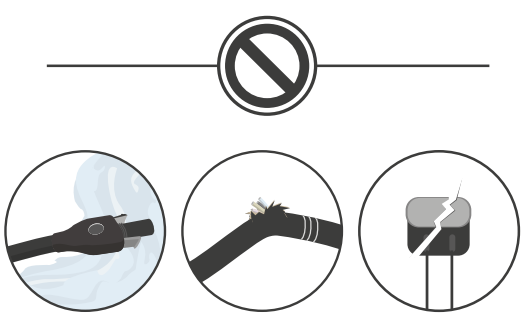

! → Do not connect modules with different orientations or angles of inclination in the same string.

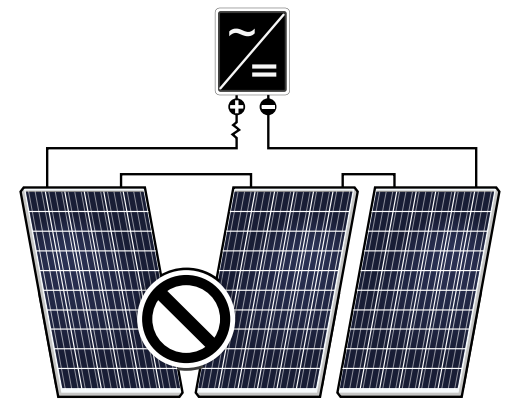

! → Ensure for a tight connection between the plugs. Plugs click together audibly.

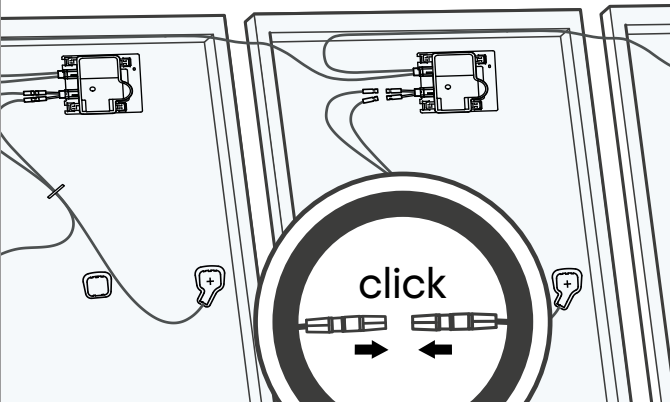

4 ELECTRICAL CONNECTION

4.4 AFTER INSTALLATION

! → Ensure that all necessary safety and functional tests have been carried out according to applicable standards.

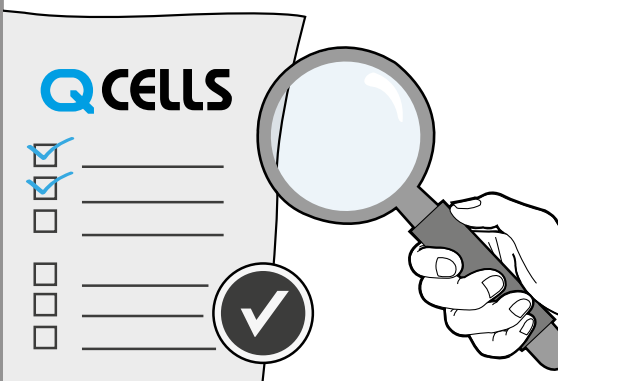

! **NOTE! Module damage may occur!**

→ Ensure that the plug connections are secured away from any water-channeling surface.

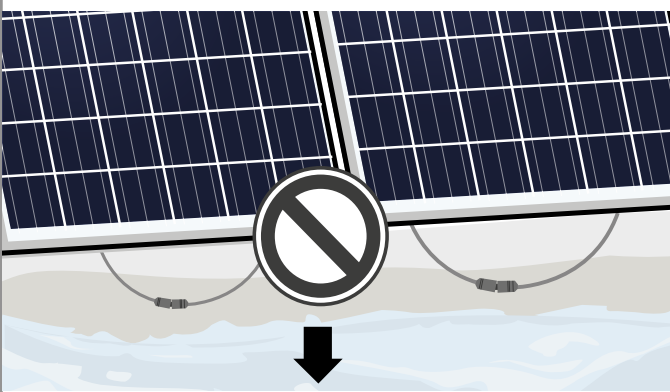

! → Integrate the system into the existing lightning protection system in accordance with the applicable local regulations.

→ The Enphase Microinverter has field-adjustable voltage and frequency trip points that may need to be set, depending upon local requirements. Only an authorized installer with the permission and following requirements of the local electrical authorities should make adjustments.



! **WARNING! Fire Risk!**

→ Do not use light concentrators (e.g., mirrors or lenses).

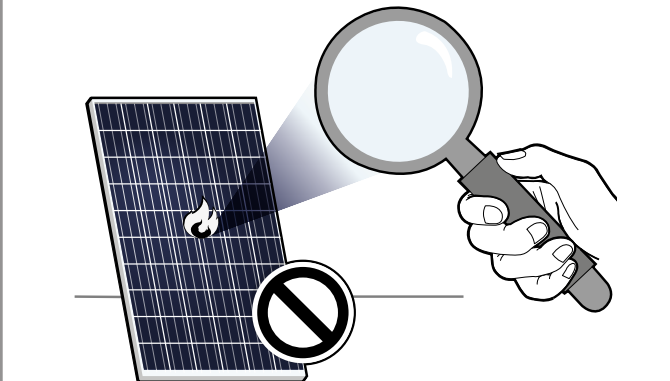

! → Ensure that the cabling is not exposed and / or hanging and is protected from dirt, moisture and mechanical friction.

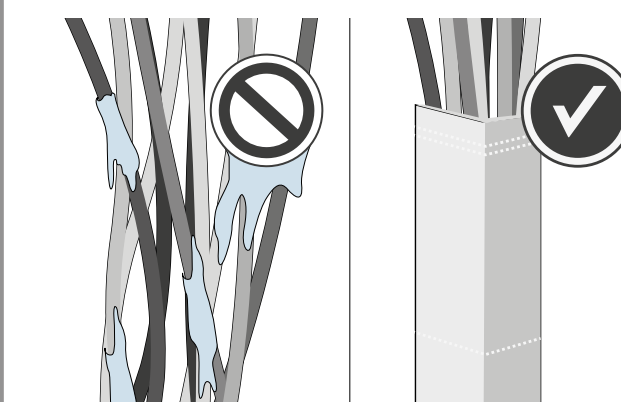

5 GROUNDING

Protective Grounding

In order to prevent electrical shock or fire, the frame of the module as well as any non-current-carrying metal parts of the system must be grounded. While this section provides some information about grounding the Q CELLS frames and modules, reference should be made to local statutes and regulations for specific requirements on grounding. The U.S. National Electrical Code addresses these issues in Article 250.

Proper grounding is achieved by bonding all exposed non-current-carrying metal equipment to the appropriately sized equipment grounding conductor (EGC) or racking system that can be used for integrated grounding.

Q CELLS frames are protected from corrosion with an anodized coating, which has to be penetrated in order to ensure proper bonding. The different methods listed below are suggested methods for an appropriate bond between the frame and the EGC or racking system (that will have to be properly grounded). The method appropriate for any individual installation will depend on multiple factors.

Option A: Use of a Grounding Lug

A listed grounding lug can be bonded to the frame using the grounding holes pre-drilled in the frame. These holes are marked with a ground symbol, as shown below on the frame section drawing. To install the grounding lug, follow the specified instructions of the manufacturer. The grounding lug should be made of stainless steel or tin plated metals such as aluminum to avoid corrosion.

The grounding lug should be attached to the frame grounding hole using a stainless steel screw, toothed lock washer or KEPS nut (in order to penetrate the anodized layer) and backing nut. Care should be taken to avoid the use of grounding hardware of dissimilar metals, which may lead to corrosion.

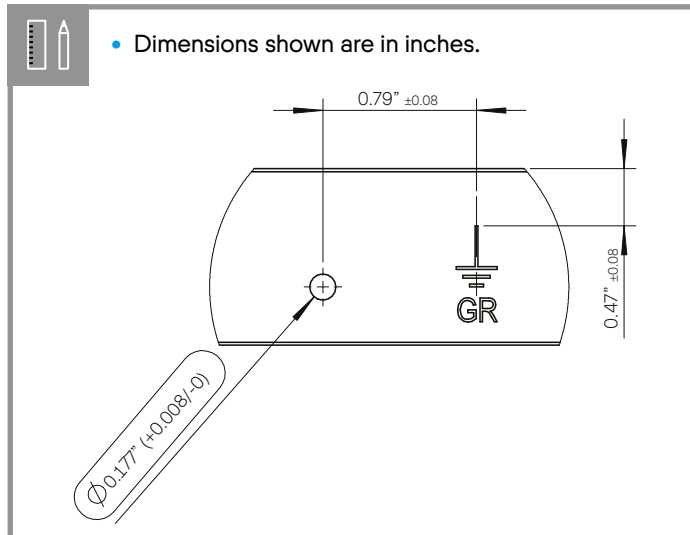

5 GROUNDING

Option B: Grounding Methods

Q CELLS modules can be bonded and grounded with a racking system certified to UL 2703 for Bonding and Grounding that has been evaluated and listed as compatible with Q CELLS modules. In such cases the entire system can be appropriately bonded and grounded when installed per the racking systems instructions with appropriate system grounding.

Q CELLS Modules are generally compatible with Racking Integrated Bonding solutions, but the racking UL 2703 Listing and Installation manual should be checked to insure the module is Listed. Examples of integrated bonding solutions would be Wiley WEEB® washers or IronRidge's UFO, some of these products can be used multiple times or only once before requiring replacement. Refer to the Racking Manufacturers installation manual for instructions on installation and replacement. Refer to Wiley's installation instructions for the specific use of WEEB washers.

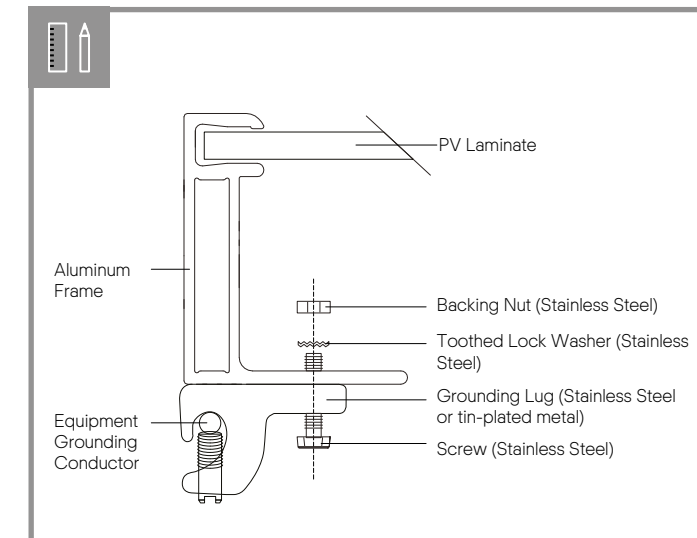

6 FAULTS AND DEFECTS

DANGER!
Risk of fatal injury due to electric shock!

- ➔ Do not attempt to fix any problems yourself (e.g., glass cracks, damaged cables).
- ➔ Contact an installer or Q CELLS Technical Customer Service Department.

7 DISPOSAL

- ➔ Do not disconnect modules yourself.
- ➔ Commission a trade specialist.
- ➔ Dispose of modules in accordance with the local disposal regulations.

Q CELLS solar modules are known for a long operating life and minimal maintenance effort and expense. Dirt and grime are usually washed away by rain. If the module is fully or partially shaded by dirt or debris (e.g., plants, bird droppings), it needs to be cleaned to prevent a loss of performance.

Maintenance

- The PV system has to be inspected regularly by certified personnel.
- The time intervals and extent of the inspection can depend on local circumstances (e.g., salt, ammonia content in the air, high humidity etc.). The customer / operator must inform him / herself about time intervals and extend of necessary inspections.
- Inspections must be performed especially after extraordinary events (e.g., storm, hail, high snow loads etc.)
- During the inspections, it has to be checked that the components are secure, undamaged and clean.

Cleaning

WARNING!
Risk of injury due to hot and live modules!

- Only clean modules that have cooled down.
- Do not carry or wear any electrically conductive parts.

WARNING!
Risk of falling due to unsecured access!

- Never access the installation area alone or without taking adequate security precautions.
- Commission a trade specialist.

NOTE!
Module surface damage may occur!

- Remove snow and ice carefully without force (e.g., with a very soft broom).
 - Do not scratch off dirt.
 - Rinse dirt (dust, leaves, etc.) off with lukewarm water or use, only for the glass surface, an alcohol based glass cleaner. Do not use abrasive detergents or surfactants for any part of the panel.
 - Use a soft cellulose cloth (kitchen roll) or sponge to carefully wipe off stubborn dirt. Do not use micro fleece wool or cotton cloths.
- Isopropyl alcohol (IPA) can be used selectively to remove stubborn dirt and stains within one hour after emergence.**
- Follow the safety guidelines provided by the IPA manufacturer.
 - Do not let IPA run down between the module and the frame or into the module edges.

NOTE! Module damage may occur!

→ Do not clean modules with water if there is a risk of frost.



→ Remove dirt with lukewarm water or alcohol based glass cleaner, a broom, or a soft cloth.

→ Do not use surfactants, rotating brushes, scrapers, or any high-pressure water cleaning equipment.



→ Free the substructure from any dirt and debris (leaves, bird nests, etc.).





Important Safety Information

Read this First





To install AC Modules (solar panels), read and follow all warnings and instructions in this guide. Safety precautions are listed at the back of this guide.

The Enphase Microinverters that are pre-installed on the backs of the ACM do not require grounding electrode conductors (GEC), equipment grounding conductors (EGC), or grounded conductor (neutral). The microinverter has a Class II double-insulated rating, which includes ground fault protection (GFP).

IMPORTANT: The ACM requires the Q Cable and is not compatible with previous Enphase cabling. An IQ Envoy is required to monitor performance of the ACMs. The Q Accessories work only with Enphase IQ Series Microinverters.





Product Labels

The following symbols appear on the **product label** and are described here:

-  **WARNING:** Hot surface.
-  **DANGER:** Refer to safety instructions.
-  **DANGER:** Risk of electrical shock.
-  **Refer to manual**
-  **Double-insulated**

Safety and Advisory Symbols





To reduce the risk of electric shock, and to ensure the safe installation and operation of the Enphase IQ System, the following safety symbols appear throughout this document to indicate dangerous conditions and important safety instructions.

	DANGER:	This indicates a hazardous situation, which if not avoided, will result in death or serious injury.
	WARNING:	This indicates a situation where failure to follow instructions may be a safety hazard or cause equipment malfunction. Use extreme caution and follow instructions carefully.
	WARNING:	This indicates a situation where failure to follow instructions may result in burn injury.
	NOTE:	This indicates information that is very important for optimal system operation. Follow instructions closely.







IQ 7+ Microinverter Safety Instructions

General Safety





	DANGER: Risk of electric shock. Risk of fire.	<p>Only use electrical system components approved for wet locations.</p> <p>Only qualified personnel should install, troubleshoot, or replace Enphase Microinverters or Enphase Q Cable and Accessories.</p> <p>Ensure that all AC and DC wiring is correct and that none of the AC or DC wires are pinched, shorted or damaged. Ensure that all AC junction boxes are properly closed.</p> <p>Do not exceed the maximum number of microinverters in an AC branch circuit as listed in the manual. You must protect each microinverter AC branch circuit with a 20 A maximum breaker or fuse as appropriate.</p>
	DANGER: Risk of electric shock.	<p>Do not use Enphase equipment in a manner not specified by the manufacturer. Doing so may cause death or injury to persons, or damage to equipment.</p> <p>Be aware that installation of this equipment includes risk of electric shock.</p> <p>The DC conductors of this photovoltaic system are ungrounded and may be energized.</p> <p>Always de-energize the AC branch circuit before servicing. Enphase does not recommend disconnecting the DC connectors under load.</p>
	WARNINGS:	<p>Before installing or using the Enphase Microinverter, read all instructions and cautionary markings in the technical description, on the Enphase equipment and on the photovoltaic (PV) equipment.</p> <p>Do not connect Enphase Microinverters to the grid or energize the AC circuit(s) until you have completed all of the installation procedures and have received approval from the electrical utility company.</p> <p>When the PV array is exposed to light, DC voltage is supplied to the power conversion equipment (PCE).</p> <p>Risk of equipment damage. Enphase male and female connectors must only be mated with the matching male/female connector.</p>
	NOTES:	<p>To ensure optimal reliability and to meet warranty requirements, install the Enphase equipment according to the instructions in this manual.</p> <p>The AC and DC connectors on the cabling are rated as a disconnect only when used with an Enphase Microinverter.</p> <p>Protection against lightning and resulting voltage surge must be in accordance with local standards.</p> <p>Perform all electrical installations in accordance with all applicable local electrical codes, such as: the Canadian Electrical Code, Part 1; ANSI requirements; and NPFA 70 (NEC).</p>

Microinverter Safety

	WARNING: Risk of skin burn.	The body of the Enphase Microinverter is the heat sink. Under normal operating conditions, the temperature could be 20° C above ambient, but under extreme conditions the microinverter can reach a temperature of 90° C. To reduce risk of burns, use caution when working with microinverters.
	DANGER: Risk of electric shock. Risk of fire.	<p>Only qualified personnel may connect the Enphase Microinverter to the utility grid.</p> <p>Do not attempt to repair the Enphase Microinverter; it contains no user-serviceable parts. If it fails, contact Enphase customer service to obtain a return merchandise authorization (RMA) number and start the replacement process. Tampering with or opening the Enphase Microinverter will void the warranty.</p>
	WARNING: Risk of equipment damage	The Enphase Microinverter is not protected from damage due to moisture trapped in cabling systems. Never mate microinverters to cables that have been left disconnected and exposed to wet conditions. This voids the Enphase warranty.
	NOTES:	The Enphase Microinverter has field-adjustable voltage and frequency trip points that may need to be set, depending upon local requirements. Only an authorized installer with the permission and following requirements of the local electrical authorities should make adjustments.



Enphase Q Cable and Accessory Safety

	DANGER: Risk of electric shock.	Do not install the Enphase Q Cable terminator while power is connected.
	WARNING: Risk of electric shock. Risk of fire.	<p>When stripping the sheath from the Q Cable, make sure the conductors are not damaged. If the exposed wires are damaged, the system may not function properly.</p> <p>Do not leave AC connectors on the Q Cable uncovered for an extended period. You must cover any unused connector with a sealing cap.</p> <p>Make sure protective sealing caps have been installed on all unused AC connectors. Unused AC connectors are live when the system is energized.</p>
	WARNING:	<p>Use the terminator only once. If you open the terminator following installation, the latching mechanism is destroyed. If the latching mechanism is defective, do not use the terminator. Do not circumvent or manipulate the latching mechanism.</p> <p>When installing the Enphase Q Cable, secure any loose cable to minimize tripping hazard.</p>
	NOTES:	<p>When looping the Enphase Q Cable, do not form loops smaller than 4.75" (12 cm) in diameter.</p> <p>If you need to remove a sealing cap, you must use the Enphase disconnect tool.</p> <p>When installing the Enphase Q Cable and accessories, adhere to the following:</p> <ul style="list-style-type: none"> Do not expose the terminator cap or cable connections to directed, pressurized liquid (water jets, etc.). Do not expose the terminator or cable to continuous immersion. Do not expose the terminator cap or cable connections to continuous tension (e.g., tension due to pulling or bending the cable near the connection). Use only the connectors provided. Do not allow contamination or debris in the connectors. Use the terminator cap and cable connections only when all parts are present and intact. Do not install or use in potentially explosive environments. Do not allow the terminator to come into contact with open flame. Fit the terminator cap using only the prescribed tools and in the prescribed manner. Use the terminator to seal the conductor end of the Enphase Q Cable; no other method is allowed.



PV Rapid Shutdown Equipment (PVRSE)

This product is UL Listed as PV Rapid Shut Down Equipment and conforms with NEC-2014 and NEC-2017 section 690.12 and C22.1-2015 Rule 64-218 Rapid Shutdown of PV Systems, for AC and DC conductors, when installed according to the following requirements:

- Microinverters and all DC connections must be installed inside the array boundary. Enphase further requires that the microinverters and DC connections be installed under the PV module to avoid direct exposure to rain, UV, and other harmful weather events.
- The array boundary is defined as 305 mm (1 ft.) from the array in all directions, or 1 m (3 ft.) from the point of entry inside a building.

This rapid shutdown system must be provided with an initiating device and (or with) status indicator which must be installed in a location accessible to first responders or be connected to an automatic system which initiates rapid shutdown upon the activation of a system disconnect or activation of another type of emergency system.

The initiator shall be listed and identified as a disconnecting means that plainly indicates whether it is in the “off” or “on” position. Examples are:

- Service disconnecting means
- PV system disconnecting means
- Readily accessible switch or circuit breaker

The handle position of a switch or circuit breaker is suitable for use as an indicator. Refer to NEC or CSA C22.1-2015 for more information.

Additionally, in a prominent location near the initiator device, a placard or label must be provided with a permanent marking including the following wording:

'PHOTOVOLTAIC SYSTEM EQUIPPED WITH RAPID SHUTDOWN' The term 'PHOTOVOLTAIC' may be replaced with 'PV.'

The placard, label, or directory shall be reflective, with all letters capitalized and having a minimum height of 9.5 mm (3/8") in white on red background.



Enphase Microinverter Installation

Installing the Enphase IQ7+ Microinverter for ACM involves several key steps. Each step listed here is detailed in the following pages.

- Step 1: Install a Junction Box**
- Step 2: Position and Connect the Enphase Q Cable**
- Step 3: Terminate the Unused End of the Q Cable**
- Step 4: Prepare the ACMs**
- Step 5: Create the Installation Map**
- Step 6: Mount the ACMs**
- Step 7: Connect the Microinverters**
- Step 8: Manage the Cabling**
- Step 9: Ground the ACMs**
- Step 10: Energize the System**
- Step 11: Set Up and Activate Monitoring**

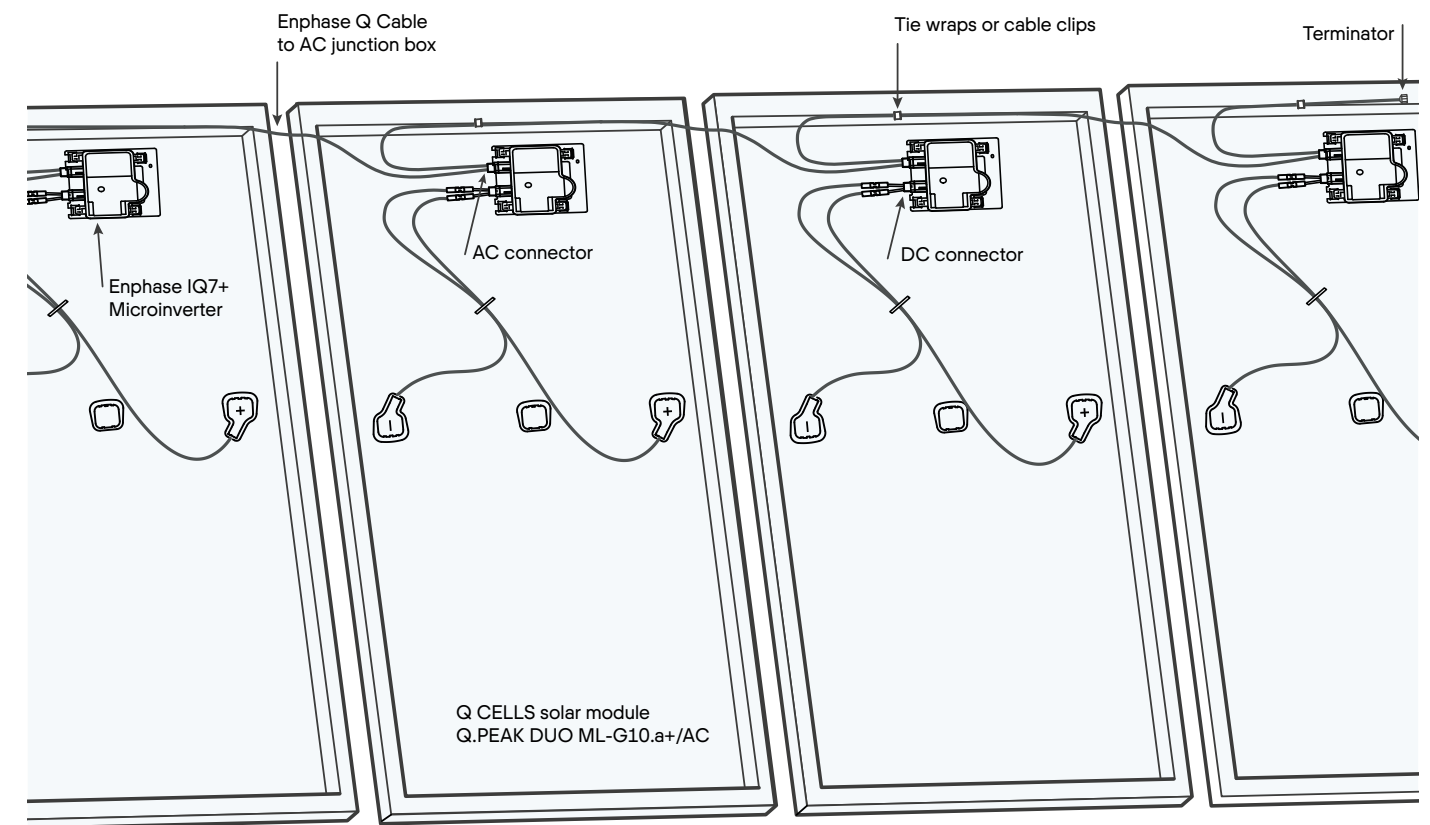



Step 1: Install a Junction Box

- A. Verify that AC voltage at the site is within range.

Service Type and Voltage: L1-L2	
240 V Split-Phase	211 to 264 VAC
208 V Single-Phase	183 to 229 VAC

- B. Install a junction box at a suitable location on the racking.
 C. Provide an AC connection from the junction box back to the electricity network using equipment and practices as required by local jurisdictions.

Step 2: Position and Connect the Enphase Q Cable

- A. Plan each cable segment to allow drop connectors on the Enphase Q Cable to align with each AC Module. Allow extra length for slack, cable turns, and any obstructions.
 B. Mark the approximate centers of each PV module on the PV racking.
 C. Lay out the cabling loosely on the roof for the AC branch circuit. Make sure the cable is positioned in a way that allows you to connect it to the microinverter.
 D. Cut each segment of cable to meet your planned needs.



WARNING: Do not install the modules in a way that creates continuous tension on the Q Cable. When transitioning between rows, secure the cable to the rail to prevent cable or connector damage. Do not count on the connector to withstand tension.

- E. Connect the Enphase Q Cable into the AC junction box. The Q Cable uses the following wiring color code:

- Black = L1
- Red = L2

Refer to the wiring diagrams on page 47 for more information.

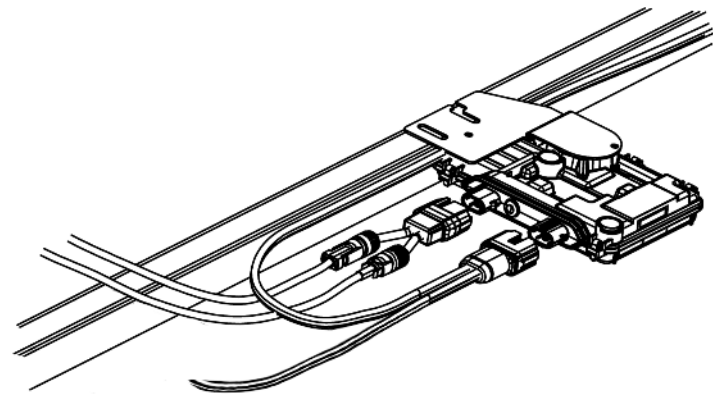

Step 3: Terminate the Unused End of the Cable

Place sealing caps on unused connectors and terminate the unused end of the Enphase Q Cable.

- A. Cover any unused connectors with Enphase Sealing Caps. Listen for a click as the connectors engage.



WARNING: Risk of electric shock. Risk of fire. Install sealing caps on all unused AC connectors as these connectors become live when the system is energized. Sealing caps are required for protection against moisture ingress.



NOTE: If you need to remove a sealing cap, you must use the Enphase Disconnect Tool. See "Remove and Replace a Microinverter" on page 43.

- B. Remove 13 mm (1/2 inch) of the cable sheath from the conductors. Use the terminator loop to measure 13 mm.

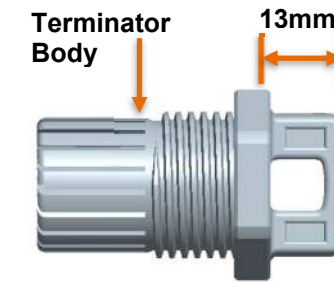

- C. Slide the hex nut onto the cable. The grommet inside of the hex nut should remain in place.
 D. Insert the cable into the terminator body so that each of the two wires land on opposite sides of the internal separator.

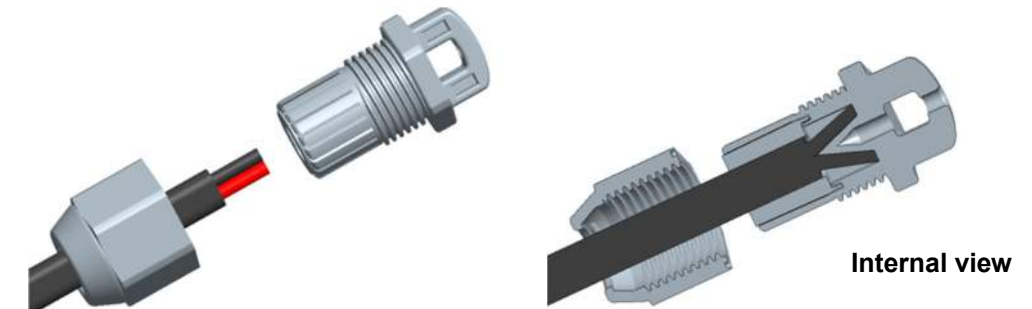

- E. Insert a screwdriver into the slot on the top of the terminator to hold it in place and torque the nut to 7 Nm.
 F. Hold the terminator body stationary with the screwdriver and turn only the hex nut to prevent conductors from twisting out of the separator.



NOTE: Turn only the hex nut to prevent conductors from twisting out of the separator.

- G. Attach the terminated cable end to the PV racking with a cable clip or tie wrap so that the cable and terminator do not touch the roof.



WARNING: The terminator cannot be re-used. If you unscrew the nut, you must discard the terminator.





Step 4: Prepare the AC Modules

- A. Before installing the AC module, the microinverters must be lifted from the shipping position. On the ground, turn the AC Module so that the microinverter faces you. Using both hands, lift the microinverter up. You will hear four clicks as the microinverter locks into the installation position. Ensure the four latches are locked, and the microinverter is not tilted.

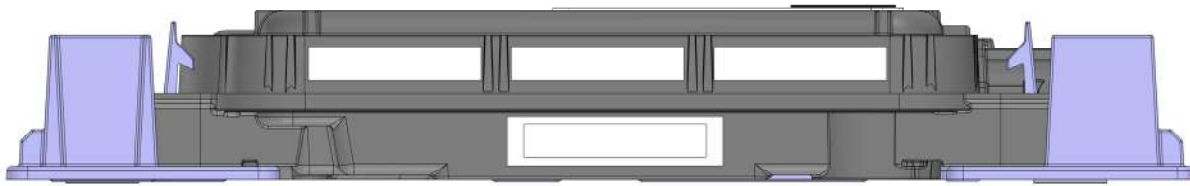

The Microinverter is in the shipping position.

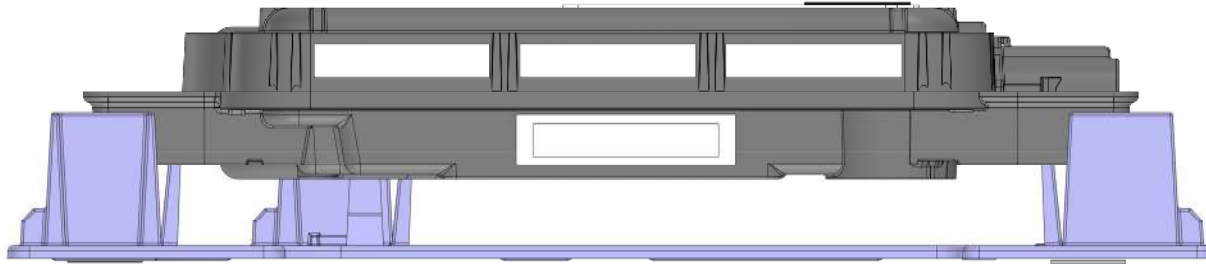

The Microinverter is lifted and ready for installation.

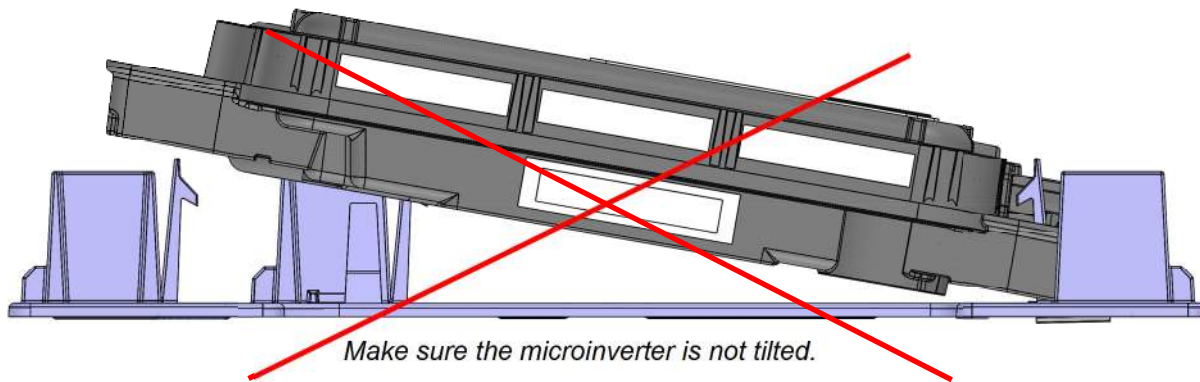

Make sure the microinverter is not tilted.

NOTE: If you need to move the module, you can return the microinverter to the shipping position using the Enphase Disconnect Tool. Use the tool to depress the four locking mechanisms on each corner of the microinverter to return it to the shipping position.

- B. Installer has to scan the microinverter Serial Number using the Enphase Installer Toolkit mobile app.
- C. Position the AC Modules as planned on the rail.



Use this end of the disconnect tool to depress the locking mechanisms.



Step 5: Mount the ACMs

You can use clamps or module mounting holes to mount the modules on the installation or you can use an embedded system. If using an alternative mounting solution, contact to be sure that is covered by the warranty. Refer to the mounting options on pages 14 and 15 for more information.

- A. Install the ACM with a clearance of at least 10 cm (4 in.) from the roof. Also, make sure that the microinverter on the underside of the ACM is at least 1.9 cm (0.75 in.) away from the roof or installation surface.
- B. Do not place the ACMs in such a way that places pressure on the microinverter. Minimum distance from the top edge of the module to the rail should be about 270 mm (11.02 in.).
- C. Make sure that the minimum gap between modules is 10 mm (0.4 in.) or greater.
- D. Check that rails and clamps are clear of the microinverter by at least 3.8 cm (1.5 in.). Do not obstruct module drain holes.

Step 6: Connect the Microinverters as you Install the ACMs

- A. Check again that the ACMs are not placing pressure on the microinverter. Minimum distance from the top edge of the module to the rail should be about 30 cm (12 in.).
- B. As you install each ACM, connect the Q Cable to the microinverter. Listen for a click as the connectors engage.
- C. Cover any unused connectors on the AC cable with Enphase Sealing Caps. Listen for a click as the sealing caps engage.



WARNING: Risk of electric shock. Risk of fire. Install sealing caps on all unused AC connectors as these connectors become live when the system is energized. Sealing caps are required for protection against moisture ingress.

Step 7: Manage the Cabling

- A. Use cable clips to attach the cable to the module frame. Leave no more than 1.8 m (six feet) between cable clips.

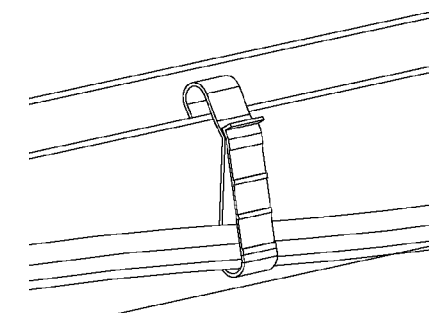

Cable clip

- B. Dress any excess cabling in loops so that it does not contact the roof. Do not form loops smaller than 12 cm (4¾ ") in diameter.



Step 8. Ground the ACMs

Choose to use grounding clamps or module mounting holes to ground the modules. Or, you can use a reliable third-party grounding system.

All Methods:

- A. Ground the module frames to protect the array from lightning and static-electricity damage using Method A, B, or C.
- B. Be sure that the grounding device will fully contact the inner side of the aluminum alloy and penetrate the frame surface oxide film.
- C. Make a connection from the grounding conductor to earth using a suitable earth ground electrode.



WARNING: Risk of equipment damage. Do not drill additional grounding holes on module frame. The module frame has been drilled and marked for grounding. Use the Grounding holes only for grounding, and do not use them for mounting or other purposes.



NOTE: The grounding conductor or strap can be copper, copper alloy, or any other material acceptable for use as an electrical conductor per the National Electrical Codes. The grounding wire material and size must meet all local and regional requirements.

Method A: Grounding with grounding clamps.

- Locate the grounding hole (diameter Ø4 mm) at the edge of the module frame back.
- Use 12 AWG copper core wire for the grounding clamp, and do not damaged the copper wire during installation.
- Torque to 2.3N•m.

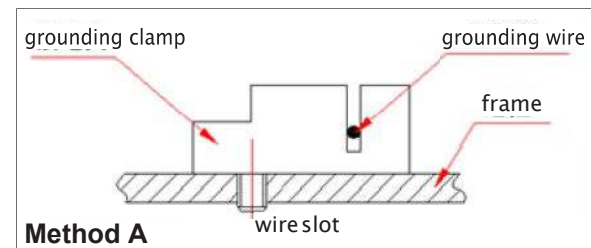

Method B: Grounding with unused mounting holes.

You can use the frame edge grounding holes or unused mounting holes on the ACM for installing grounding devices.

- Align a grounding clamp to the frame hole and place a grounding bolt through the grounding clamp and frame.
- Place the toothed side of the washer as shown and fasten the nuts.
- Place the grounding wire through the grounding clamp and tighten the nuts.

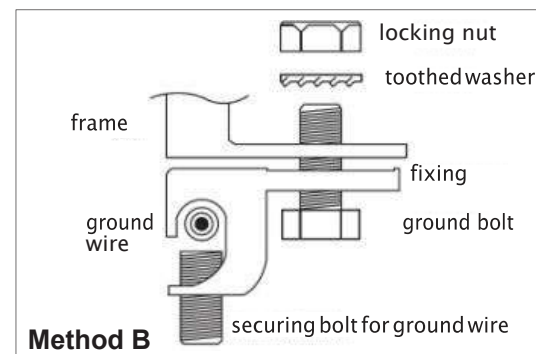

Method C: Grounding with third party hardware.

You can use third party grounding devices for grounding of solar modules, but these devices must be reliable and must be operated per manufacturer instructions.



Step 9: Energize the System

- A. If applicable, turn ON the AC disconnect or circuit breaker for the branch circuit.
- B. Turn ON the main utility-grid AC circuit breaker. Your system starts producing power **after a five-minute wait time.**
- C. Check the LED on the connector side of the microinverter:

LED color	Indicates
Flashing green	Normal operation. AC grid function is normal there is communication with the IQ Envoy.
Flashing orange	The AC grid is normal but there is no communication with the IQ Envoy.
Flashing Red	The AC grid is either not present or not within specification.
Solid Red	There is an active "DC Resistance Low, Power Off Condition." To reset, refer to "DC Resistance Low – Power Off Condition" on page 40.

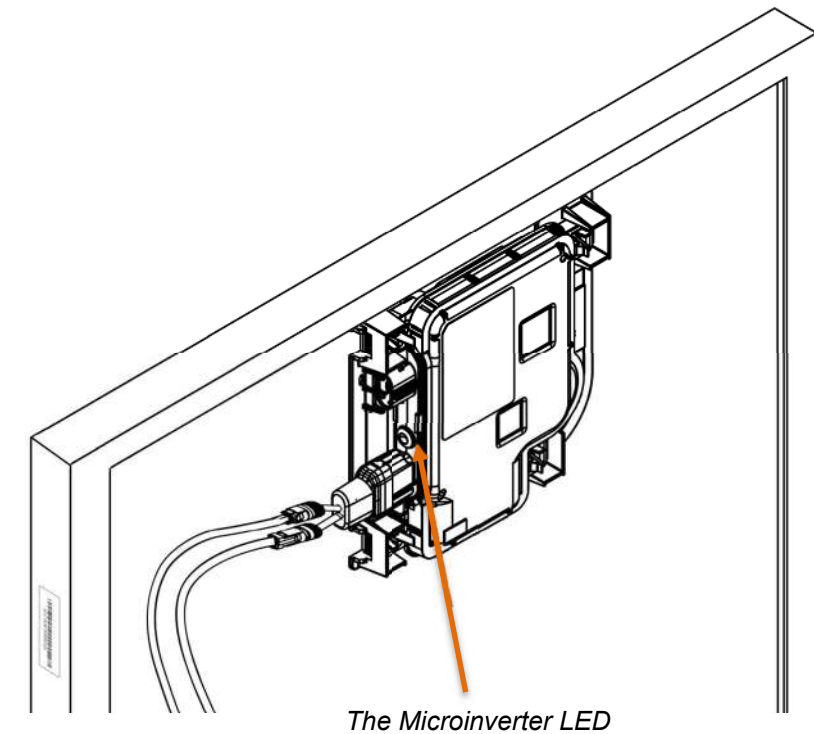



Step 10: Set Up and Activate Monitoring

Refer to the *Enphase IQ Envoy Quick Install Guide* to install the IQ Envoy and set up system monitoring and grid management functions. This guide leads you through the following:

- Connecting the IQ Envoy
- Detecting devices and scanning the installation map
- Connecting to Enlighten
- Registering the system
- Building the virtual array



NOTE: When the utility requires a profile other than the default IEEE 1547 (for example grids managed by Hawaii Electric Industries [HEI] including HECO) you must select an appropriate grid profile for your installation. You can set the grid profile through Enlighten, during system registration, or through Installer Toolkit at any time. You must have an Enphase Envoy communications gateway to set or change the grid profile. For more information on setting or changing the grid profile, refer to the *Enphase IQ Envoy Installation and Operation Manual* at enphase.com/support.



Troubleshooting

Follow all the safety measures described throughout this manual. Qualified personnel can use the following troubleshooting steps if the PV system does not operate correctly.



WARNING: Risk of electric shock. Do not attempt to repair the Enphase Microinverter; it contains no user-serviceable parts. If it fails, contact Enphase customer service to obtain an RMA (return merchandise authorization) number and start the replacement process.

Status LED Indications and Error Reporting

The LED indications are described in Step 9, see page 38.

LED Operation

The status LED on each microinverter lights green about six seconds after DC power is applied. It remains lit solid for two minutes, followed by six green blinks. After that, red blinks indicate that no grid is present if the system is not yet energized.

Any short red blinks after DC power is first applied to the microinverter indicate a failure during microinverter startup.

DC Resistance Low – Power Off Condition

For **all IQ Microinverter for ACM models**, a solid red status LED when DC power has been cycled indicates the microinverter has detected a DC Resistance Low – Power Off event. The LED will remain red and the fault will continue to be reported by the Envoy until the error has been cleared.

An insulation resistance (IR) sensor in the microinverter measures the resistance between the positive and negative PV inputs to ground. If either resistance drops below a threshold, the microinverter stops power production and raises this condition. This may indicate defective module insulation, defective wiring or connectors, moisture ingress, or a similar problem. Although the cause may be temporary, this microinverter condition persists until the sensor is manually reset.

An IQ Envoy is required to clear this condition. The condition clears on operator command unless its cause is still present.

If a microinverter registers a “DC Resistance Low - Power Off” condition, you can attempt to clear this condition. If the condition does not clear after you perform the following procedure, contact Enphase Energy customer support at enphase.com/en-us/support/contact.

There are two ways to send a clear message to the microinverter. Note that the condition will not clear after sensor reset if the cause of the failure is still present. If the condition persists, contact your installer.

Method 1: Clear this Error Using Enlighten

- Log in to Enlighten and access the system.
- Click the **Events** tab. The next screen shows a current “DC Resistance Low - Power Off” condition for the system.
- Click **DC Resistance Low - Power Off**.
- Where “n” is the number of affected devices, click **n devices (show details)**.
- Click the serial number of the affected microinverter.
- Click **Reset DC Resistance Low - Power Off Sensor**.



The system displays, “A DC Resistance Low- Power Off reset task was issued on [date and time] for this microinverter and is still pending.”

Method 2: Use Installer Toolkit to Clear the Condition

Follow the instructions in the *Enphase IQ Envoy Installation and Operation Manual* at enphase.com/support to clear this condition.

Other Faults

All other faults are reported to the Envoy. Refer to the *Enphase IQ Envoy Installation and Operation Manual* at enphase.com/support for troubleshooting procedures.



Troubleshoot an Inoperable Microinverter

To troubleshoot an inoperable microinverter, follow the steps in the order shown.



WARNING: Risk of electric shock. Always de-energize the AC branch circuit before servicing. Never disconnect the DC connectors under load.



WARNING: The Enphase Microinverters are powered by DC power from the PV modules. Make sure you disconnect the DC connections and reconnect DC power and then watch for the solid green about six seconds after connection to DC power.

- A. Make sure AC breakers and disconnects are closed.
- B. Check the connection to the utility grid and verify that the utility voltage is within allowable ranges.
- C. Verify that AC line voltages at all solar power circuit breakers at the load center and subpanels are within the ranges shown in the following table.
- D. Verify that AC line voltage at the junction box for each AC branch circuit is within the ranges shown in the following table:

240 Volt AC, Single Phase	
L1 to L2	211 to 264 VAC
L1, L2 to ground	106 to 132 VAC
208 Volt AC, Single Phase	
L1 to L2	183 to 229 VAC
L1, L2 to ground	106 to 132 VAC

- E. Using an Enphase disconnect tool, disconnect the AC cable for the microinverter in question from the Enphase Q Cable.
- F. Verify that utility power is present at the microinverter by measuring line to line and line to ground at the Enphase Q Cable connector.
- G. Visually check that the AC branch circuit connections (Enphase Q Cable and AC connections) are properly seated. Reseat if necessary. Check also for damage, such as rodent damage.
- H. Make sure that any upstream AC disconnects, as well as the dedicated circuit breakers for each AC branch circuit, are functioning properly and are closed.
- I. Disconnect and re-connect the Enphase DC connectors. The status LED of each microinverter will light solid green a few seconds after connection to DC power and then blink green six times to indicate normal start-up operation about two minutes after connecting to DC power. The LED subsequently resumes normal operation if the grid is present. See page 38 for normal LED operation.
- J. Attach an ammeter clamp to one conductor of the DC cables from the PV module to measure microinverter current. This will be under one amp if AC is disconnected.
- K. Verify the PV module DC voltage is within the allowable range shown in “Specifications” on page 6 of this manual.



- L. Following the steps in *Remove and Replace a Microinverter*, remove the PV panel from the roof, and swap out the microinverter with one from a known good, adjacent AC module. If after checking Enlighten periodically (this may take up to 30 minutes), the problem moves to the adjacent module, this indicates that the PV module isn't functioning correctly. If it stays in place, the problem is with the original microinverter. Contact [Enphase Customer Support](#) for help in reading the microinverter data and for help in obtaining a replacement microinverter, if needed.
- M. Check the DC connections between the microinverter and the PV module. The connection may need to be tightened or reseated. If the connection is worn or damaged, it may need replacement.
- N. Verify with your utility that line frequency is within range.
- O. If the problem persists, contact Customer Support at enphase.com/en-us/support/contact.

Remove and Replace a Microinverter

If problems remain after following the troubleshooting steps listed previously, contact Enphase at enphase.com/en-us/support/contact. If Enphase authorizes a replacement, follow the steps below. To ensure the microinverter is not disconnected from the PV modules under load, follow the disconnection steps in the order shown:



- A. De-energize the AC branch circuit breaker.
- B. Enphase AC connectors are tool-removable only. To disconnect the microinverter from the Enphase Q Cable, insert the disconnect tool and remove the connector.
- C. Remove the AC Module from the roof per manufacturer instructions.
- D. Once on the ground, disconnect the PV module DC connector from the microinverter using the Enphase disconnect tool.
- E. Press each of the four clips to free the microinverter.
- F. Snap new replacement microinverter into place.
- G. Connect the PV Module DC connectors to the microinverter.
- H. Scan the new serial number.



NOTE: The serial number of the replacement microinverter will differ from the serial number on the AC Module frame.

- I. Bring the AC Module back onto the roof or other mounting location.
- J. Connect the AC Module AC connector and DC Connector to the Q Cable.
- K. Energize the AC branch circuit breaker and verify operation of the replacement microinverter by checking the Status LED on the connector side of the microinverter.



- L. On the ground, use the Installer Toolkit mobile app to delete the old microinverter serial number from the Enphase IQ Envoy database. In Installer Toolkit, once connected to the Envoy:
 - a. Tap **Micros > Manage**.
 - b. Tap the checkbox  to the right of the microinverter serial number that you replaced.
 - c. Tap  to delete the microinverter from the Envoy-S database.
- M. Add the new microinverter serial number to the Envoy database by initiating a device scan using one of the following methods:
 - a. **Method 1: Initiate a scan using the Installer Toolkit mobile app**
 - In Installer Toolkit, once connected to the IQ Envoy, navigate to the Overview screen.
 - From the Overview screen, tap **Detected > Start Device Scan** to start a new 30-minute device scan.
 - If device scanning on the IQ Envoy is inhibited, the app displays **Scan Inhibited**. If you need to add more microinverters to the system when device scanning is inhibited on the IQ Envoy, you must use the Installer Toolkit scanning tool to provision them on the IQ Envoy, rather than using the IQ Envoy's device scanning function to discover them. If this is not possible and you need to enable device scanning on the IQ Envoy, contact Enphase Customer Support at enphase.com/en-us/support/contact.
 - b. **Method 2: Use an IQ Envoy**
 - Press the **Device Scan** button on the IQ Envoy. The IQ Envoy begins a 15-minute scan to identify all of the microinverters deployed at the site. The Microinverter Communications LED  flashes green during the scan.

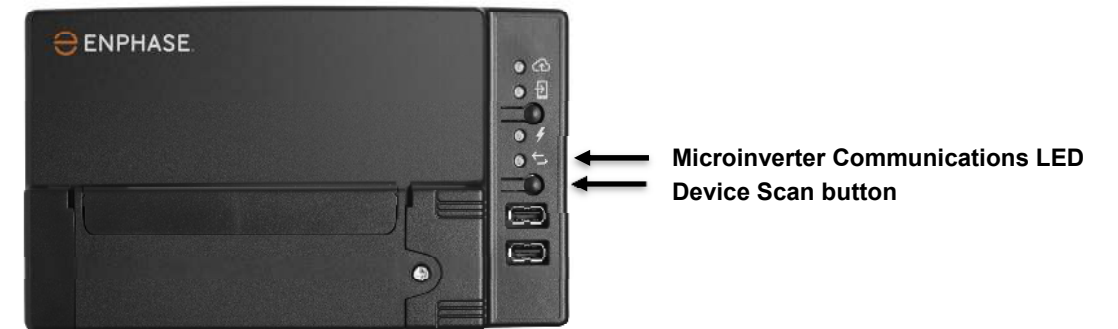

- N. Log in to Enlighten to use Enlighten's Array Builder to add the newly detected microinverter to the virtual array.
- O. Ship the old microinverter to Enphase using the supplied return-shipping label.



Enphase Q Cable Planning and Ordering

The Enphase Q Cable is a continuous length of 12 AWG, double insulated, outdoor-rated cable with integrated connectors for microinverters. These connectors are preinstalled along the Q Cable at intervals to accommodate varying PV module widths. The microinverters plug directly into the cable connectors.

The cabling is compatible with a variety of PV racking systems. For a list of approved PV racking systems, refer to the PV Racking Compatibility document on the Enphase website at enphase.com/support.

Connector Spacing Options

Q Cable is available in three connector spacing options. The gap between connectors on the cable can be 1.3 meters, 2.0 meters, or 2.3 meters. The 1.3 meter spacing is best suited for connecting PV modules installed in portrait orientation, while the 2.0 meter and 2.3 meter spacing allows you to install 60-cell and 72-cell PV modules in landscape orientation, respectively.

Cabling Options

Ordering options include:

Cable Model	Connector spacing	PV module orientation	Connector count per box
Q-12-10-240	1.3m (50")	Portrait	240
Q-12-17-240	2.0m (78")	Landscape (60-cell)	240
Q-12-20-200	2.3m (90")	Landscape (72-cell)	200

The cabling system is flexible enough to adapt to almost any solar design. To determine the cable type you need, apply the following considerations:

- When mixing PV modules in both portrait and landscape orientation, you may need to transition between cable types. See the preceding table for available cable types.
- To transition between cable types, install a field wireable connector.
- In situations where portrait modules are widely spaced, you may need to use landscape spaced cables for the portrait-oriented PV modules and create loops of excess cable, if needed.



WARNING: Do not form loops smaller than 12 cm (4.75") in diameter.



Grid Interconnection Details

Enphase IQ 7 Microinverters are grid support interactive inverters. This type of inverter is also known as a Grid Support Utility Interactive Inverter (GSUII). The IQ 7 and IQ 7+ also comply with California Rule 21 - 2016 and Hawaii Rule 14H - 2017.

Grid Profiles

IQ 7 and IQ 7+ Microinverters have field-adjustable voltage and frequency trip points. Trip points are input voltage and frequency values that trigger the microinverters to shut down when the values are exceeded. If local regulations require adjustments to these trip points, or if the grid profile was not set up during registration, the installer can set up the system to use an alternate Grid Profile (set of trip points).



NOTE: Only an authorized installer, following the requirements of the local electrical utility, is allowed to make Grid Profile adjustments.



NOTE: Grid profile changes are applied only after a microinverter is detected.

In some regions and in some situations, microinverter trip points may be adjusted to account for high grid voltage or for local conditions.

Grid profile management tasks include:

- Set the grid profile for your region
- View or verify current trip point settings
- Generate a report for confirmation of site settings to the utility or other authority

To modify the grid profile or the parameters within the grid profile, installers must log in to their Enlighten account using their credentials.

The following tables show the parameter settings for the grid profiles available for North America:



NOTE: Simultaneous use of Fixed Power Factor and Volt/VAr is not supported.

Manufacturer's Stated Accuracy

Measurement	Default Tolerance of Measurement
Volts	+/- 1%
Amps	+/- 2%
Watts	+/- 5%
VAr	+/- 3%
Displacement power factor	+/- 2%
Hz	+/- 0.1 Hz
Time	The greater of +/- 2 cycles or 0.1% of total clearing time

Sample Wiring Diagram:

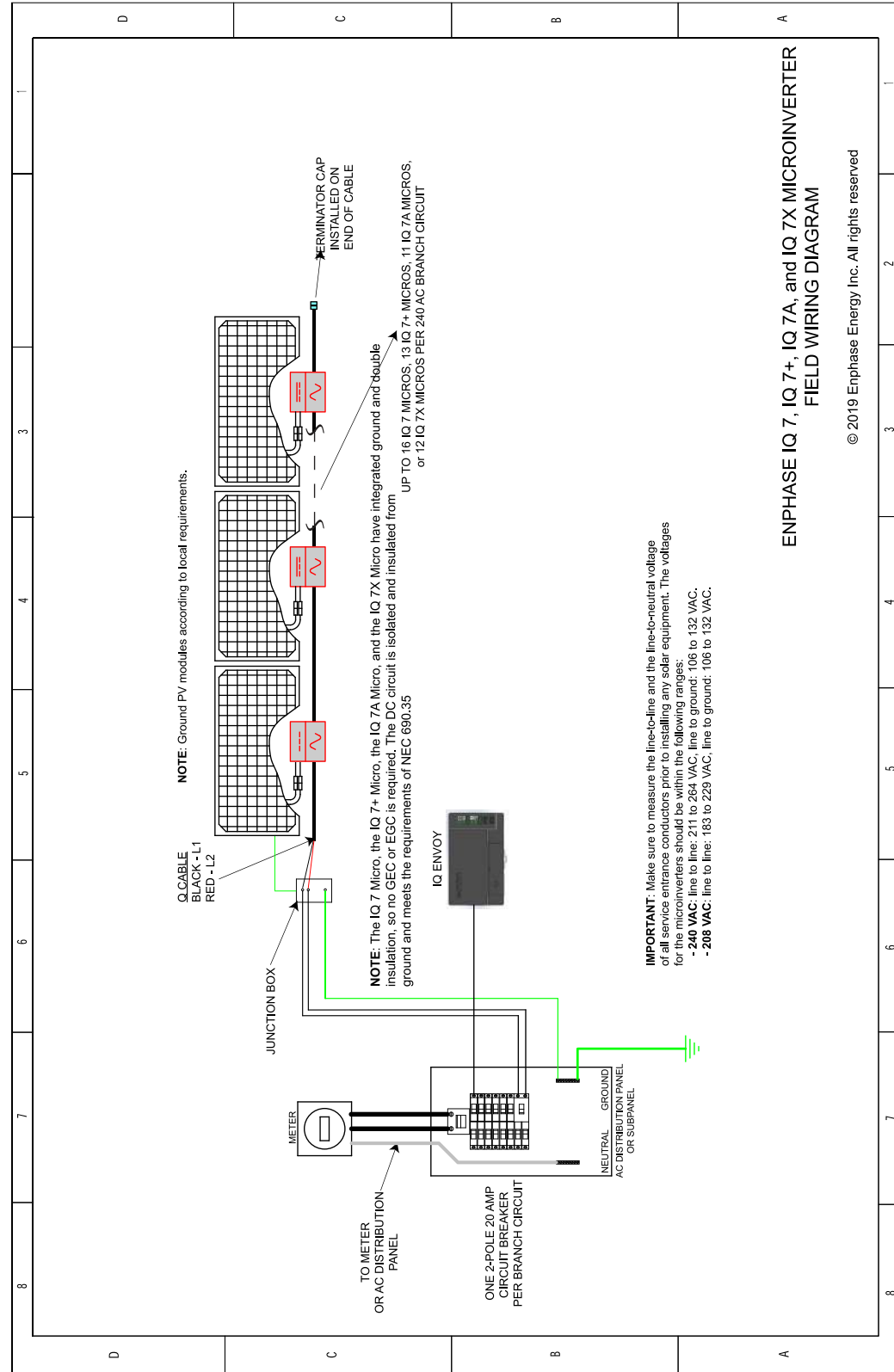

HANWHA Q CELLS AMERICA INC.

400 Spectrum Center Drive
Suite 1400
Irvine, CA 92618
USA

TEL +1 949 748 59 69
EMAIL inquiry@us.q-cells.com
WEB www.q-cells.us