

Original MC4

Renewable Energy | Solar Photovoltaics

EN



Female and male cable coupler MC4

As individual part with open crimp contact (including insulating part)



Female cable coupler PV-KBT4...



Male cable coupler PV-KST4...

- In accordance with NEC 2023, requires a tool to open.
- Proven MULTILAM technology with high long-term stability, which ensures consistently low performance loss throughout the entire service life of the plug connector.
- Tried and tested plug connectors, over 15 years of experience in the field.
- Available for assembly with cross-sections up to 10 mm².
- Also available as ready made leads according to customer's specification.
- To be used with suitable mated connectors from the MC4 product family and suitable cable.

Technical data

Technical data	
Ambient temperature range	-40 °C...+85 °C (TÜV/UL)
Upper limiting temperature	105 °C
Degree of protection	IP68 (1 m, 168 h)/IP65
Degree of protection, unmated	IP2X
Degree of pollution	3
Max. contact resistance of the connector	0.25 mΩ
Rated Impulse Voltage	16 kV
Contact system	MULTILAM
Type of connection	Crimping
Contact material	Copper, tin plated
Insulation material	PC/PA
Locking system	Locking Type
Fire protection class	UL94:V-0
Ammonia resistance (acc. to DLG)	yes
Salt mist spray test, degree of severity 6	yes
TÜV Rheinland certifications number	R 60127190
TÜV Rheinland 2 PFG 2330	R 60087448
UL-File number	E343181
CSA number of certificate	250725
CQC number of certificate	CQC20024256431
JET number of certificate	B19T0013

Dimensional drawings

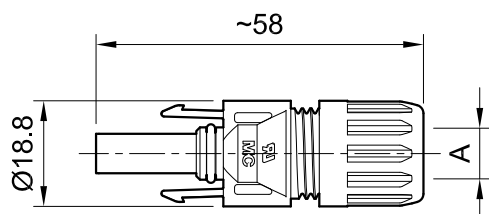

Female cable coupler PV-KBT4...

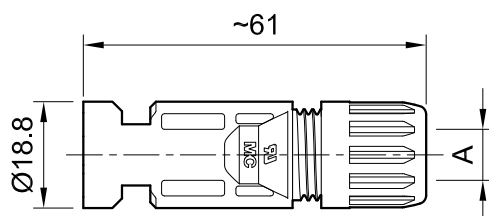
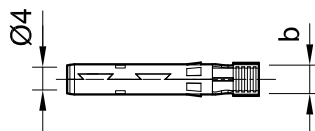

Male cable coupler PV-KST4...

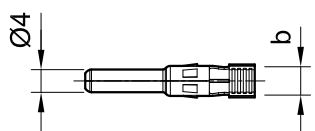

Ordering information

Order No.	Type	Socket	Plug	Outer diameter of cable	Width of crimp opening	IEC 62852			UL 6703			Approvals				
						mm ²	DC V	A	AWG	DC V	A	TÜV	UR	CSA	CQC	JET
32.0010P0001-UR	PV-KBT4/2,5I-UR	x		5.0 – 6.0	4.0	2.5	1000	22.5				x	x	x		x
									14	1500	30					
32.0011P0001-UR	PV-KST4/2,5I-UR		x	5.0 – 6.0	4.0	2.5	1000	22.5				x	x	x		x
									14	1500	30					
32.0140P0001-UR	PV-KBT4/2,5X-UR	x		5.5 – 7.4	4.0	2.5	1000	22.5				x	x			x
									14	1500	30					
32.0141P0001-UR	PV-KST4/2,5X-UR		x	5.5 – 7.4	4.0	2.5	1000	22.5				x	x			x
									14	1500	30					
32.0012P0001-UR	PV-KBT4/2,5II-UR	x		5.9 – 8.8	4.0	2.5	1000	22.5				x	x	x	x	x
									14	1500	30					
32.0013P0001-UR	PV-KST4/2,5II-UR		x	5.9 – 8.8	4.0	2.5	1000	22.5				x	x	x	x	x
									14	1500	30					
32.0014P0001-UR	PV-KBT4/6I-UR	x		5.0 – 6.0	5.8	4	1000	39				x	x	x		x
						6	1000	39								
									12	1500	35					
									10	1500	50					
32.0015P0001-UR	PV-KST4/6I-UR		x	5.0 – 6.0	5.8	4	1000	39				x	x	x		x
						6	1000	39								
									12	1500	35					
									10	1500	50					
32.0142P0001-UR	PV-KBT4/6X-UR	x		5.5 – 7.4	5.8	4	1000	39				x	x			x
						6	1000	39								
									12	1500	35					
									10	1500	50					
32.0143P0001-UR	PV-KST4/6X-UR		x	5.5 – 7.4	5.8	4	1000	39				x	x			x
						6	1000	39								
									12	1500	35					
									10	1500	50					
32.0016P0001-UR	PV-KBT4/6II-UR	x		5.9 – 8.8	5.8	4	1000	39				x	x	x	x	x
						6	1000	39								
									12	1500	35					
									10	1500	50					

Order No.	Type	Socket	Plug	Outer diameter of cable	Width of crimp opening	IEC 62852			UL 6703			Approvals				
						mm ²	DC V	A	AWG	DC V	A	TÜV	UR	CSA	CQC	JET
32.0017P0001-UR	PV-KST4/6II-UR		x	5.9 – 8.8	5.8	4	1000	39				x	x	x	x	x
						6	1000	39								
									12	1500	35					
								10	1500	50						
32.0034P0001	PV-KBT4/10II	x		5.9 – 8.8	6.5	10	1000	45				x				x
32.0035P0001	PV-KST4/10II		x	5.9 – 8.8	6.5	10	1000	45				x				x

Note:

For more detailed information concerning the suitable cable gland range, please consult corresponding assembly instructions (see “Further information”).

Note:

Unmated connectors must be protected from any contamination using Stäubli sealing caps. For ordering information concerning Stäubli sealing caps, please consult corresponding catalog (see “Further information”).

Further information



Female and male cable coupler with barrel crimp contacts

For cable coupler with barrel crimp contacts, please consult:
www.staubli.com/re-downloads.html → English → Catalog → **Cable coupler with barrel crimp contacts**



Tools and accessories

For related Stäubli tools and accessories please consult:
www.staubli.com/re-downloads.html → English → Catalog → **Tools and accessories**



Assembly instructions

For assembly instructions for “Female and male cable coupler MC4” please consult:
www.staubli.com/re-downloads.html → English → Assembly info → **MA231**

Female and male cable coupler MC4

Open crimp contacts on carrier band (including insulating part)



Female cable coupler PV-KBT4...



Male cable coupler PV-KST4...

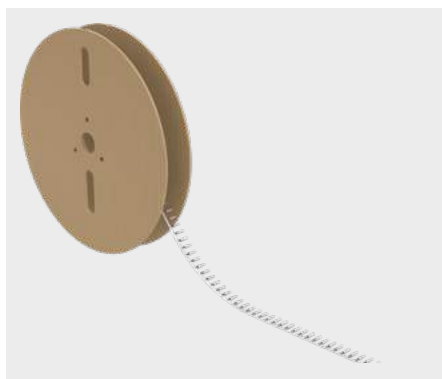

Reel with contacts

- In accordance with NEC 2023, requires a tool to open.
- Proven MULTILAM technology with high long-term stability, which ensures consistently low performance loss throughout the entire service life of the plug connector.
- Tried and tested plug connectors, over 15 years of experience in the field.
- Available for assembly with cross-sections up to 10 mm².
- To be used with suitable mated connectors from the MC4 product family and suitable cable.
- Also available as ready made leads according to customer's specification.

Technical data

Technical data	
Ambient temperature range	-40 °C...+85 °C (TÜV/UL)
Upper limiting temperature	105 °C
Degree of protection	IP68 (1 m, 168 h)/IP65
Degree of protection, unmated	IP2X
Degree of pollution	3
Max. contact resistance of the connector	0.25 mΩ
Rated Impulse Voltage	16 kV
Contact system	MULTILAM
Type of connection	Crimping
Contact material	Copper, tin plated
Insulation material	PC/PA
Locking system	Locking Type

Technical data

Fire protection class	UL94:V-0
Ammonia resistance (acc. to DLG)	yes
Salt mist spray test, degree of severity 6	yes
TÜV Rheinland certifications number	R 60127190
TÜV Rheinland 2 PFG 2330	R 60087448
UL-File number	E343181
CSA number of certificate	250725
CQC number of certificate	CQC20024256431
JET number of certificate	B19T0013

Dimensional drawings

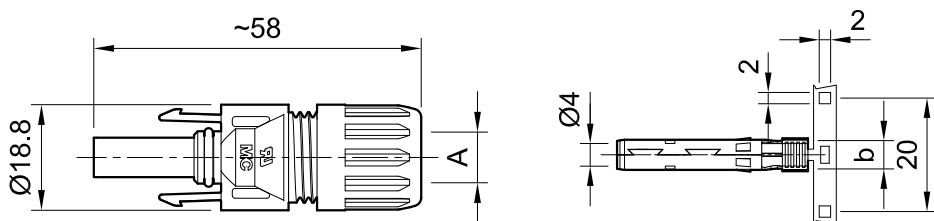

Female cable coupler PV-KBT4...

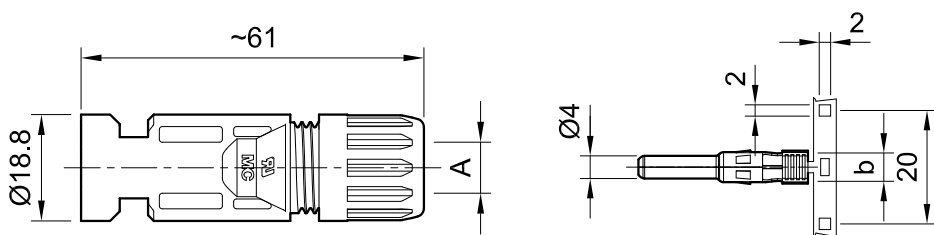

Male cable coupler PV-KST4...

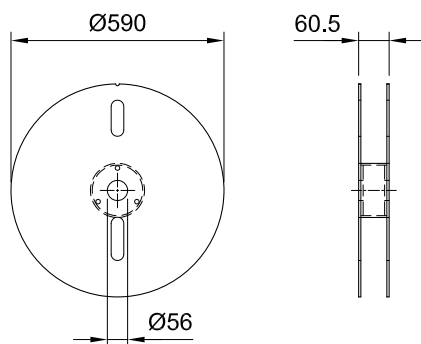

Reel with contacts

Ordering information

Order No.	Type	Socket	Plug	Outer diameter of cable	Width of crimp opening	IEC 62852			UL 6703			Contacts per reel	Approvals					
						mm ²	DC V	A	AWG	DC V	A		TÜV	UR	CSA	CQC	JET	
				A (mm)	b (mm)													
32.0010P2000-UR	PV-KBT4/2,5I-UR	x		5.0 – 6.0	4.0	2.5	1000	22.5				2000	x	x	x			x
									14	1500	30							
32.0011P2000-UR	PV-KST4/2,5I-UR		x	5.0 – 6.0	4.0	2.5	1000	22.5				2000	x	x	x			x
									14	1500	30							
32.0140P2000-UR	PV-KBT4/2,5X-UR	x		5.5 – 7.4	4.0	2.5	1000	22.5				2000	x	x				x
									14	1500	30							
32.0141P2000-UR	PV-KST4/2,5X-UR		x	5.5 – 7.4	4.0	2.5	1000	22.5				2000	x	x				x
									14	1500	30							
32.0012P2000-UR	PV-KBT4/2,5II-UR	x		5.9 – 8.8	4.0	2.5	1000	22.5				2000	x	x	x	x	x	x
									14	1500	30							
32.0013P2000-UR	PV-KST4/2,5II-UR		x	5.9 – 8.8	4.0	2.5	1000	22.5				2000	x	x	x	x	x	x
									14	1500	30							
32.0014P2000-UR	PV-KBT4/6I-UR	x		5.0 – 6.0	5.8	4	1000	39				2000	x	x	x			x
						6	1000	39										
									12	1500	35							
									10	1500	50							
32.0015P2000-UR	PV-KST4/6I-UR		x	5.0 – 6.0	5.8	4	1000	39				2000	x	x	x			x
						6	1000	39										
									12	1500	35							
									10	1500	50							
32.0142P2000-UR	PV-KBT4/6X-UR	x		5.5 – 7.4	5.8	4	1000	39				2000	x	x				x
						6	1000	39										
									12	1500	35							
									10	1500	50							
32.0143P2000-UR	PV-KST4/6X-UR		x	5.5 – 7.4	5.8	4	1000	39				2000	x	x				x
						6	1000	39										
									12	1500	35							
									10	1500	50							
32.0016P2000-UR	PV-KBT4/6II-UR	x		5.9 – 8.8	5.8	4	1000	39				2000	x	x	x	x	x	x
						6	1000	39										
									12	1500	35							
									10	1500	50							

Order No.	Type	Socket	Plug	Outer diameter of cable	Width of crimp opening	IEC 62852			UL 6703			Contacts per reel	Approvals					
						mm ²	DC V	A	AWG	DC V	A		TÜV	UR	CSA	CQC	JET	
32.0017P2000-UR	PV-KST4/6II-UR		x	5.9 – 8.8	5.8	4	1000	39				2000	x	x	x	x	x	
						6	1000	39										
									12	1500	35							
									10	1500	50							
32.0034P1500	PV-KBT4/10II	x		5.9 – 8.8	6.5	10	1000	45				1500	x					x
32.0035P1500	PV-KST4/10II		x	5.9 – 8.8	6.5	10	1000	45				1500	x					x

Note:

For more detailed information concerning the suitable cable gland range, please consult corresponding assembly instructions (see “Further information”).

Note:

Unmated connectors must be protected from any contamination using Stäubli sealing caps. For ordering information concerning Stäubli sealing caps, please consult corresponding catalog (see “Further information”).

Further information



Tools and accessories

For related Stäubli tools and accessories please consult:
www.staubli.com/re-downloads.html → English → Catalog → **Tools and accessories**



Assembly instructions

For assembly instructions for “Female and male cable coupler MC4” please consult:
www.staubli.com/re-downloads.html → English → Assembly info → **MA231**

Female and male panel receptacle MC4

As individual part (including insulating part)



Female panel receptacle PV-ADBP4-S2...



Male panel receptacle PV-ADSP4-S2...

- MC4 panel-receptacle connectors are the interface between an inverter or junction box or junction and a branch cable.
- Mounting directly by means of screw thread or in perforated plate with plastic nut (included in delivery).
- Rapid, precise plugging.
- Protection class IP66 guarantees the highest connection safety.
- To be used with suitable mated connectors from the MC4 product family and suitable cable.
- Includes sealing element for enclosure.

Technical data

Technical data	
Ambient temperature range	-40 °C...+85 °C (TÜV/UL)
Upper limiting temperature	105 °C
Degree of protection	IP66
Degree of protection, unmated	IP2X
Degree of pollution	3
Max. contact resistance of the connector	0.25 mΩ
Rated Impulse Voltage	16 kV
Contact system	MULTILAM
Type of connection	Crimping
Contact material	Copper, tin plated
Insulation material	PC/PA
Locking system	Locking Type
Fire protection class	UL94:V-0
TÜV Rheinland certifications number	R 60127181
UL-File number	E343181
CSA number of certificate	250725

Dimensional drawings

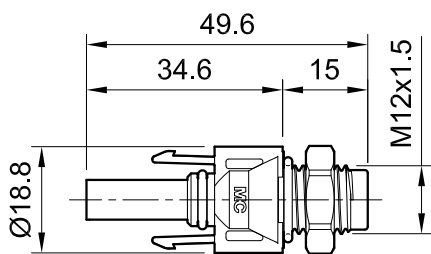

Female panel receptacle PV-ADBP4-S2...

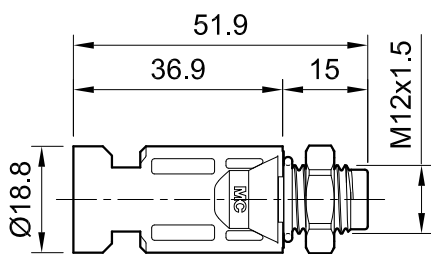
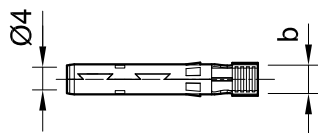

Male panel receptacle PV-ADSP4-S2...

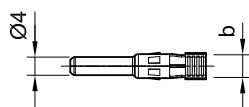

Ordering information

Order No.	Type	Socket	Plug	Width of crimp opening	IEC 62852			UL 6703			Approvals			
					b (mm)	mm ²	DC V	A	AWG	DC V	A	TÜV	UR	CSA
32.0076P0001-UR	PV-ADBP4-S2-UR/2,5	x		4.0	1.5	1250	17.5							
					2.5	1250	22.5				x	x	x	
								14	1500	30				
32.0077P0001-UR	PV-ADSP4-S2-UR/2,5		x	4.0	1.5	1250	17.5							
					2.5	1250	22.5				x	x	x	
								14	1500	30				
32.0078P0001-UR	PV-ADBP4-S2-UR/6	x		5.8	4	1250	39							
					6	1250	45				x	x	x	
								12	1500	35				
								10	1500	50				
32.0079P0001-UR	PV-ADSP4-S2-UR/6		x	5.8	4	1250	39							
					6	1250	45				x	x	x	
								12	1500	35				
								10	1500	50				
32.0150P0001	PV-ADBP4-S2/10	x		6.5	10	1250	51					x		
32.0151P0001	PV-ADSP4-S2/10		x	6.5	10	1250	51					x		

Note:

For more detailed information concerning the suitable cable gland range, please consult corresponding assembly instructions (see “Further information”).

Note:

Unmated connectors must be protected from any contamination using Stäubli sealing caps. For ordering information concerning Stäubli sealing caps, please consult corresponding catalog (see “Further information”).

Further information



Tools and accessories

For related Stäubli tools and accessories please consult:

www.staubli.com/re-downloads.html → English → Catalog → **Tools and accessories**



Assembly instructions

For assembly instructions for “Female and male panel receptacle MC4” please consult:

www.staubli.com/re-downloads.html → English → Assembly info → **MA275**

Female and male panel receptacle MC4

As individual part (including insulating part)



Female panel receptacle PV-ADBP4-S2...



Male panel receptacle PV-ADSP4-S2...

- MC4 panel-receptacle connectors are the interface between an inverter or junction box or junction and a branch cable.
- Mounting directly by means of screw thread or in perforated plate with plastic nut (included in delivery).
- Rapid, precise plugging. Protection class IP66 guarantees the highest connection safety.
- To be used with suitable mated connectors from the MC4 product family and suitable cable.
- Includes sealing element for enclosure.

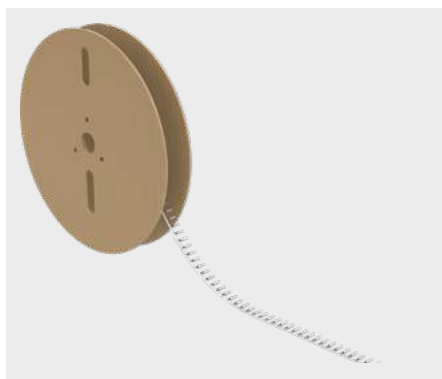

Reel with contacts

Technical data

Technical data	
Ambient temperature range	-40 °C...+85 °C
Upper limiting temperature	105 °C
Degree of protection	IP66
Degree of protection, unmated	IP2X
Degree of pollution	3
Max. contact resistance of the connector	0.25 mΩ
Rated Impulse Voltage	16 kV
Contact system	MULTILAM
Type of connection	Crimping
Contact material	Copper, tin plated
Insulation material	PC/PA

Technical data

Locking system	Locking Type
Fire protection class	UL94:V-0
TÜV Rheinland certifications number	R 60127181
UL-File number	E343181
CSA number of certificate	250725

Dimensional drawings

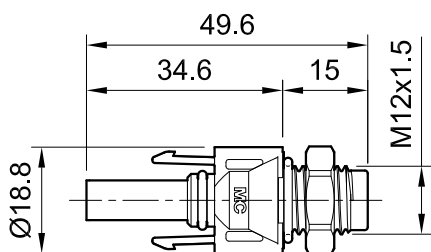

Female panel receptacle PV-ADBP4-S2...

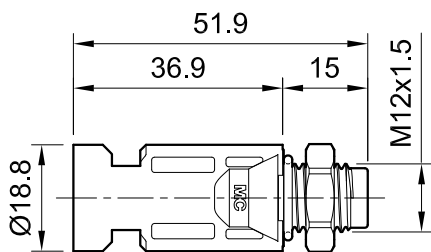
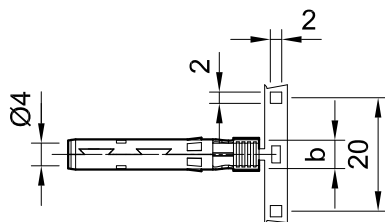

Male panel receptacle PV-ADSP4-S2...

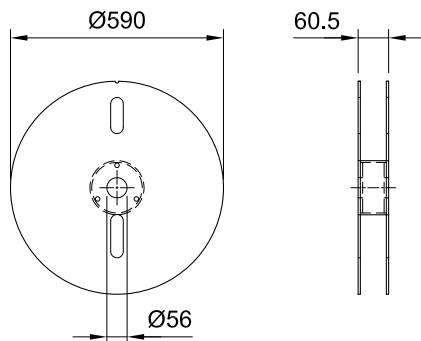
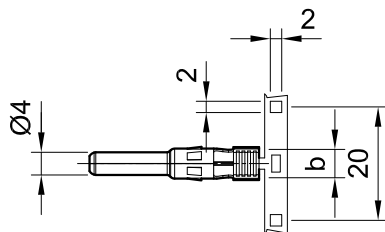

Reel with contacts

Ordering information

Order No.	Type	Socket	Plug	Width of crimp opening	IEC 62852			UL 6703			Contacts per reel	Approvals		
					mm ²	DC V	A	AWG	DC V	A		TÜV	UR	CSA
32.0076P2000-UR	PV-ADBP4-S2-UR/2,5	x		4.0	1.5	1250	17.5				2000	x	x	x
					2.5	1250	22.5							
								14	1500	30				
32.0077P2000-UR	PV-ADSP4-S2-UR/2,5		x	4.0	1.5	1250	17.5				2000	x	x	x
					2.5	1250	22.5							
								14	1500	30				
32.0078P2000-UR	PV-ADBP4-S2-UR/6	x		5.8	4	1250	39				2000	x	x	x
					6	1250	45							
								12	1500	35				
								10	1500	50				
32.0079P2000-UR	PV-ADSP4-S2-UR/6		x	5.8	4	1250	39				2000	x	x	x
					6	1250	45							
								12	1500	35				
								10	1500	50				
32.0150P1500	PV-ADBP4-S2/10	x		6.5	10	1250	51				1500	x		
32.0151P1500	PV-ADSP4-S2/10		x	6.5	10	1250	51				1500	x		

Further information



Tools and accessories

For related Stäubli tools and accessories please consult:

www.staubli.com/re-downloads.html → English → Catalog → **Tools and accessories**



Assembly instructions

For assembly instructions for “Female and male panel receptacle MC4” please consult:

www.staubli.com/re-downloads.html → English → Assembly info → **MA275**



● Stäubli Units ○ Representatives/Agents

Global presence of the Stäubli Group

www.staubli.com